

# To our loyal clients, and prospective ones:

*We welcome you to the latest DISPLAY COMPONENTS product catalogue.*

Here at DISPLAY COMPONENTS, we take the challenge seriously of making your life easier by providing innovative products to meet the needs of **plastic fabricators** and **display professionals**. This catalogue brings together an exciting range of products from global and local suppliers ranging from the small components that are an essential part of the plastic fabrication process to the components to assemble large free-standing displays.

Here is a brief overview of some of the new products that we present for the first time:

- **Plastic ticket frame systems** – an amazing range of accessories for the display builder and visual merchandiser, allowing for an almost unlimited combination of signage solutions.
- **Metal tubing connectors** – a stunning collection of components to manufacture stands and display structures from small to large in round or square tube. You will never have to custom-manufacture a welded frame again – simply utilize our range of standard tubing bends and connectors and you will have a solution that can be easily assembled and dis-assembled using basic tools.
- You will also find new products scattered through the existing catalogue sections.

Our team has also been busy refining our supply chain systems and is pleased to be able to pass on some **great savings** on many of our items. We have done this without sacrificing the quality of our products that you have come to trust.

In addition to refining our incoming supply chain, we are also pleased to announce the opening of our own **distribution centre** in metro **Sydney**. This is an exciting move that will benefit our clients on the Eastern seaboard by providing ready access to our products without the “tyranny of distance”. We can tailor a supply solution to meet your needs to ensure that we have the products that you require available when you need them.

Our team will be at your disposal and look forward to discussing your feedback and requirements.

So, until we speak, **all the best...**

The team at DISPLAY COMPONENTS

**A** PLASTIC FABRICATION COMPONENTS 1-18

**B** PLASTIC EXTRUDED SECTIONS 19-24

**C** HAND TOOLS, ADHESIVES & CLEANING 25-34

**D** CABLE & ROD DISPLAY SYSTEM 35-44

**E** BROCHURE & INFORMATION HOLDERS 45-54

**F** POSTER FRAMES & TICKET HOLDERS 55-68

**G** TICKET FRAMES 69-86

**H** METAL TUBING CONNECTORS 87-109

INDEX 110

ITEM NUMBER – PAGE INDEX 110

# A

## PLASTIC FABRICATION COMPONENTS

<b>ACRYLIC HINGES</b> .....	<b>2</b>
<b>LIVING HINGES</b> .....	<b>3</b>
<b>HANDLES &amp; KNOBS</b> .....	<b>4</b>
<b>HANGING ATTACHMENTS</b> .....	<b>4</b>
<b>SHELF CLIPS</b> .....	<b>6</b>
<b>GLUE-ON POCKETS</b> .....	<b>6</b>
<b>TURNTABLES</b> .....	<b>7</b>
<b>BUMPERS</b> .....	<b>7</b>
<b>SUCTION CAPS</b> .....	<b>7</b>
<b>DOOR CATCHES</b> .....	<b>8</b>
<b>CAM LOCKS</b> .....	<b>9</b>
<b>PLASTIC HOOKS</b> .....	<b>10</b>
<b>DISPLAY BASES</b> .....	<b>11</b>
<b>GLASS DOMES</b> .....	<b>11</b>
<b>CHROME CONNECTORS</b> .....	<b>12</b>
<b>METAL PEG HOOKS</b> .....	<b>13</b>
<b>SCANNING HOOKS – metal &amp; plastic</b> .....	<b>14</b>
<b>SPECTACLE DISPLAY ACCESSORIES</b> .....	<b>15</b>
<b>SPECTACLE ROD FITTINGS</b> .....	<b>16</b>
<b>WATCH DISPLAY FITTINGS</b> .....	<b>17</b>
<b>PLASTIC PEG HOOKS</b> .....	<b>18</b>

## ACRYL HINGE 2

High quality, transparent, solvent cementable hinge made from ultra-tough DR acrylic with self lubricating nylon pin to prevent squeaking. Designed for use on materials up to 6mm thick.

**Size:** 45mm long x 38mm wide  
**#7000** Clear, Black or White



## ACRYL-HINGE 2 SPRING LOADED

Same quality hinge features a built-in spring that returns lids and doors to closed position.

**Size:** 45mm long x 38mm wide  
**#7005** Clear Only



## SMALL HINGE

High quality, transparent, solvent cementable hinge. Suitable for applications requiring a more petite appearance.

**Size:** 38mm long x 35mm wide  
**#7002** Clear Only



## PIANO HINGE

Moulded DR acrylic clear solvent cementable piano-style hinge. May be cut to length or joined end to end. Now available in 2 convenient lengths. Incorporates channels to retain solvent flow.

**#7007** 152mm long x 41mm wide  
**#7010** 305mm long x 41mm wide



## SPRING LOADED PIANO HINGE

Built-in spring that returns lids and doors to closed position.

**#7006** 152mm long x 41mm wide  
**#7004** 305mm long x 41mm wide



We have a large range of “living” hinges which feature a flexible centre membrane with co-extruded rigid side pieces. The only flexible hinge that is recommended for outdoor use or in the presence of heavy U.V is the FLEX-FOLD. You can cut any of the flexible hinges to the exact length of you project.

## FLEX-FOLD

Transparent, all weather continuous hinge with rugged durability. Recommended for bulk food bins, golf cart windscreens, outdoor dispensers, freezer compartments and marine applications. Co-extruded from DR acrylic with tough elastomer centre section for years of continuous use. Features sleek, tapered sides and smooth surfaces that are easy to keep clean. Now available in two lengths for economical cutting.

(The flexible centre section may be strip heated and bent to form a self-closing hinge).

- #70011/4 1220mm long x 35mm wide x 5mm high
- #70011/6 1830mm long x 35mm wide x 5mm high



## FLEX-LITE

An economy version of FLEX-FOLD for interior use. Flex-Lite is manufactured from clear acrylic sides with a white flexible center.

- AP7012 1220mm long x 35mm wide x 5mm high



## SUPER 'H' HINGE

No cementing necessary with this design. A groove in your material fits over the rib in the hinge to hold without glue. Clear PVC with white centre flexible strip. 1830mm lengths.

- #7045 Fits over 4.5mm thick material
- #7046 Fits over 6mm thick material



## CLIP-ON SLATWALL CLIP

High quality injection-moulded polycarbonate attachment for clipping into pre-drilled holes into a back panel of any material from 4 – 6mm thick. Provides a secure, positive grip. Allows for items to be sent without slatwall hooks to save damage in transit.

Drill 2 x 6.5mm dia. Holes – 3 - 4.5mm thick material – down 40/60mm from top edge.  
 - 6mm thick material – down 35/55mm from top edge.



#7020

## ACRYLIC KNOB

Ergonomically designed to fit perfectly between thumb and forefinger.

#7021 25mm dia x 19mm high



## ACRYLIC PULLS

Attractive, moulded transparent handles that improve the look and feel of fabricated items.

#7022 51mm long x 9mm wide  
#7023 70mm long x 11mm wide  
#7024 89mm long x 13mm wide



## HANDLE BAR

Extruded, transparent acrylic section can be cut to you exact length and solvent bonded to doors, drawers etc.

#7027 610mm long



## 1 PEGBOARD ATTACHMENT

Solvent bonds to adapt acrylic products for pegboard or grooved wall hanging.

#7025 28mm wide x 25mm high

## 2 GROOVED WALL ATTACHMENT

Bonds to back of displays to convert to grooved wall mounting.

#7026 50mm long



## KEYHOLE ATTACHMENTS

Solvent bonds to adapt acrylic products for pegboard or grooved wall hanging.

1 #7040 22mm wide x 25mm high x 6mm thick  
2 #7041 32mm wide x 32mm high x 6mm thick



## OPEN DESIGN KEYHOLE ATTACHMENT

Incorporates centre alignment mark and open 'V' bottom for easy hanging.

#7043 19mm wide x 22mm high x 5mm thick



## SAWTOOTH HANGER ATTACHMENT

#7042 51mm wide x 19mm high x 5mm thick



## CORNER RE-INFORCING BLOCKS

The slim design of this clear high-impact acrylic block almost invisibly increases joint and construction strength. Tapered ends help prevent dirt and particle build up in corners & make for easy cleaning. Tapered on both ends or one end only for butting into corners.

#7047 6mm wide x 6mm high x 80mm long  
- tapered both ends

#7048 6mm wide x 6mm high x 45mm long  
- tapered both ends

#7049 6mm wide x 6mm high x 45mm long  
(not pictured) - tapered one end, flat other end.

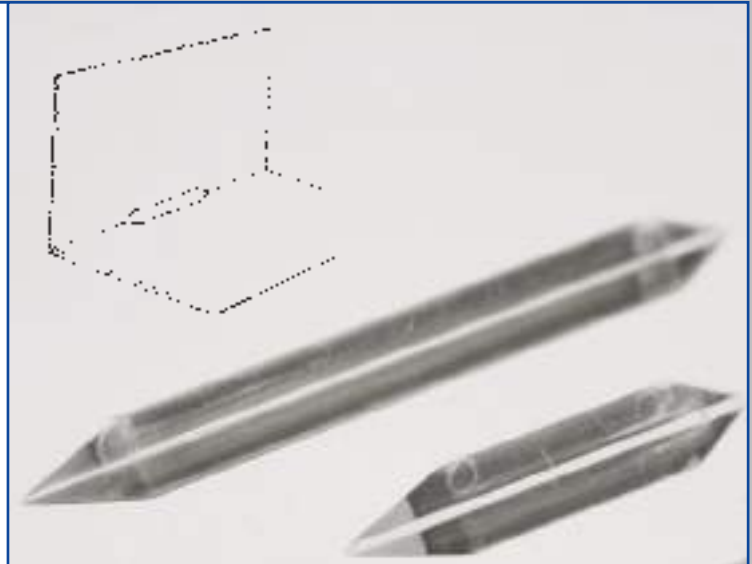

## CLEAR BUTYRATE POST & SCREW

Join two pieces of material together with this screw together fastener. Re-useable. Require 6.25mm dia hole. Head dia - 10mm

a) #0667P	Post	Length: 6mm
b) #0667S	Screw	Length: 6mm
#0668P	Post	Length: 12mm
#0668S	Screw	Length: 10mm

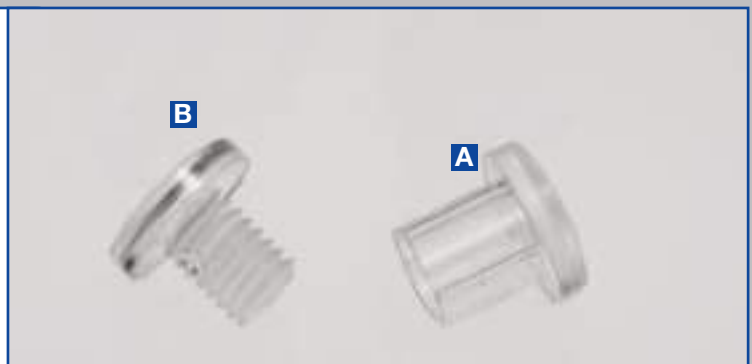

## ALUMINIUM POST & SCREW

Threaded all- aluminum fastener. All require 6.25mm dia. hole. Includes post and screw per set.

#0660	Length: 4.5mm
#0661	Length: 6mm
#0662	Length: 10mm
#0663	Length: 12mm



## SHELF CLIP/SHELF SUPPORT

Tough polycarbonate clip helps you create units that knock down for shipping and easy assembly. Clips come with 1/4" W counter sunk stainless steel screw, 20mm long. Requires 12.7mm dia hole in end panels. Use single clip for end panels, double clip for centre dividers.

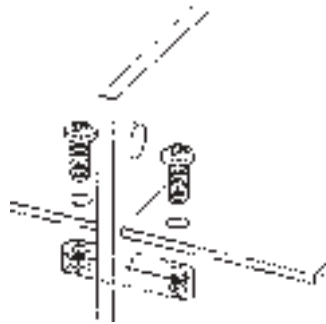

- 1 #0695 Single for ends
- 2 #0696 Double for dividers

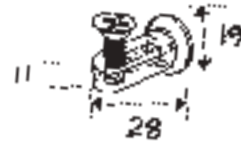

Examples of a knock-down style display using screw clips to assemble.



## TRAY DIVIDERS

Make adjustable sized pockets in J-racks and other displays. Clip over 3mm material.

#7135 32mm high x 45mm deep



## GLUE-ON BUSINESS CARD HOLDER

Easily adds on to a range of fabricated products. Has sloping base to prevent cards from leaning forward.

- 1 #7130 100mm wide x 25mm high x 22mm deep
- 2 #7133 57mm wide x 90mm high x 25mm deep



## GLUE-ON BROCHURE POCKET

These convenient pockets can be solvent bonded to acrylic displays

- 1 #7131 105mm wide x 100mm high x 25mm deep (DL)
- 2 #7134 220mm wide x 250mm high x 45mm deep (A4)





## TURNTABLES

These clear styrene turntables are quiet and free-running with internal metal ball bearings. Manufactured from PETG for superior strength.

- #7210 108mm Dia. with 20mm centre hole
- #7200 140mm Dia.
- #7201 215mm Dia.
- #7202 305mm Dia. with 215mm top turning plate
- #7203 305mm Dia. Heavy duty bearing unit

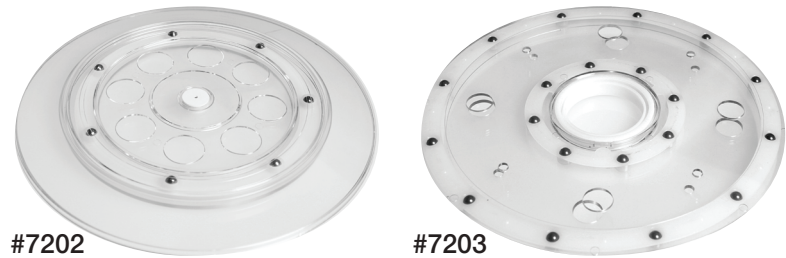

## HEAVY-DUTY LAZY SUSAN

Manufactured from black, durable ABS plastic and with a series of ball bearing supports, these turntables provide a solution for heavy-duty use. Includes cushion feet (these may be removed for attaching directly to displays).

- AP7205 320mm diameter
- AP7206 405mm diameter

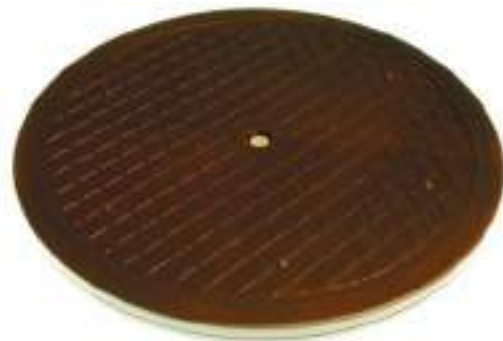

## CLEAR BUMPERS

Transparent, self sticking polyurethane bumpers to protect bottom surface of displays from scratching or sliding. Priced per bumper.

	Shape	Size (dia x ht)	No. per box	No. per pad
#7060	Hemispherical	7.9 x 2.2	5400	450
#7061	Hemispherical	11.1 x 5.5	5082	242
#7062	Cylindrical	12.7 x 3.5	5000	200

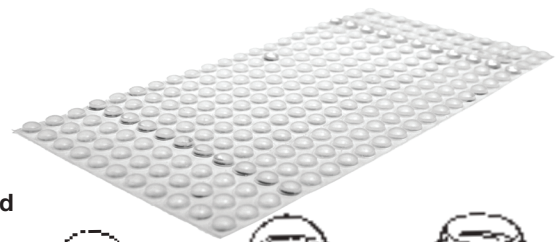

## SUCTION CUPS

Hold a variety of lightweight signs etc onto glass or shiny metal surfaces. Choose from plain or with metal hook.

Plain		With metal hook	
#0600	45mm dia	#601	45mm dia
#0603	20mm dia	#604	20mm dia
#0605	65mm dia		



## DOOR CATCH

Clear, Moulded, two-part polycarbonate catch has spring action for secure closing.

#7032 Overall length: 33mm (when closed)



## MAGNETIC CATCHES

At last, a fabricator-friendly magnetic catch that will solvent bond onto acrylic. Available in 2 sizes – for lightweight applications. Holds doors securely, yet opens with a slight pull.

**Base Length x Width x Height**  
 #7033 Small - 22mm x 10mm x 12mm  
 #7034 Large - 45mm x 10mm x 20mm



## HASP

Decorative, moulded, transparent pin-style hasp with removable pin for flat or corner mounting.

#7030 Overall length: 65mm (in flat position) x 22mm wide



## MINI HASP

2 x angle pieces per set. Hole size 10mm dia.

#7044 13mm x 13mm



## PADLOCKS

Nickel plated mini-padlock.

#7029

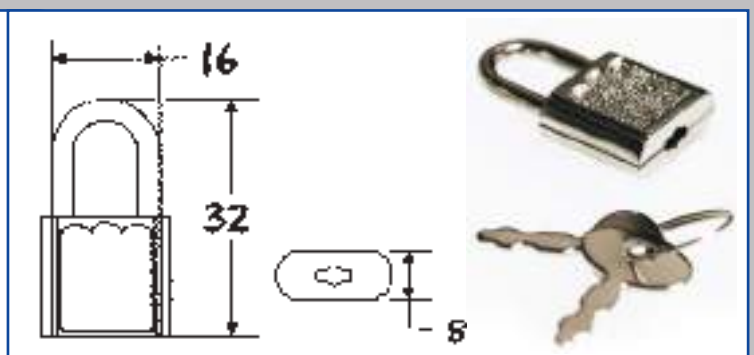

## MINI-CAMLOCK

Perfect for low security requirements of small acrylic cabinets etc.

**#7028** Hole size - 12mm dia, Housing length 16mm  
Cam length (from hole centre) 16mm



## STANDARD CAMLOCK

A simple way to add a bit more security to larger cabinets with hinged doors. Order the required cam lever separately. All standard camlocks are keyed alike.

### Lock Body (inc. 2 keys)

- 1 **#7150** Hole size - 19mm dia, Housing length 11mm
- 2 **#7151** Hole size - 19mm dia, Housing length 16mm
- #7152** Hole size - 19mm dia, Housing length 22mm

### Cam Lever

- #7160** Straight - Length (from hole centre) - 25mm
- 3 **#7161** Straight - Length (from hole centre) - 32mm
- 4 **#7162** 6mm Offset - Length (from hole centre) - 32mm



## DESK SIGN SUPPORT

Beautifully profiled and finished fitting simply attaches through 4mm dia. hole in acrylic for desk signs.

Max. panel thickness – 16mm  
Length (behind panel) – 70mm  
(Dome fastening piece protrudes 9mm in front of panel).  
Diameter at front – 9mm.

**#1973**



## HOOKS

Here's a selection of hooks that you can glue directly onto acrylic surfaces or use with a hook holder. The hook holder makes it easy to slide in and out, reducing damage in shipping and making hook replacement more economical. All hooks made from clear PETG.

	1	2	3	4
<b>Length</b>	<b>3mm round</b>	<b>6mm flat</b>	<b>10mm flat</b>	<b>10 mm ribbed</b>
25mm	#7101(a)	-	-	#7111(c)
38mm	#7102(b)	#7104(c)	-	-
50mm	#7103(b)	#7105(c)	#7108(c)	#7113(c)
63mm	-	-	#7106(d)	-
75mm	-	-	#7107(d)	#7114



## HOOK HOLDERS

The letter in bracket after the above part numbers refers to the appropriate hook holder below.

- (a) #7116 Suitable for #7101
- (b) #7117 Suitable for #7102, 3
- (c) #7118 Suitable for #7104, 5, 8, 7111, 3
- (d) #7119 Suitable for #7106, 7

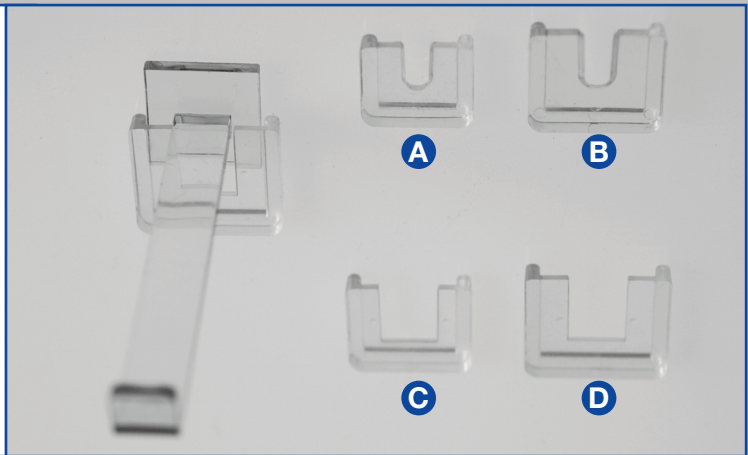

## JAY-BAR HOOKS

Moulded PETG hooks attach to Jay-Bar for jewellery displays, etc.

### Light Duty

#7109 38mm

### Heavy Duty - 10mm ribbed

#7136 38mm

#7137 50mm

#7138 75mm

#7139 100mm

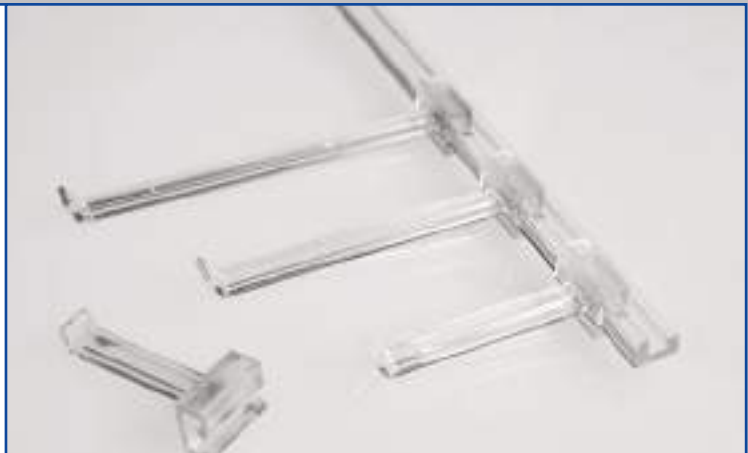

## PIN FITTING PLASTIC HOOKS

Push fit into 4.76mm pre-drilled holes on back panels of acrylic or other materials. Injection moulded in clear polycarbonate (see also PIN-MOUNTED SPECTACLE CLIPS p15).

- 'L'
- #7325 50mm
- #7326 100mm
- #7327 150mm



## GLASS DOMES

Create stunning displays with these beautifully crafted domes. Use in conjunction with our jarrah bases.

- #0370 115mm dia. x 200mm high
- #0371 200mm dia. x 300mm high



## DRILLED AND TAPPED RODS

Build any style knock-down display with these clear 19mm acrylic rods that are drilled and ready to assemble. Tapped rods are an ingenious way of fabricating displays, enabling you to ship units flat and make it easier to replace broken parts. Available with either one or both ends drilled.

Single End Drilled	Both Ends Drilled
#7350 101mm	#7360 101mm
#7351 152mm	#7361 152mm
#7352 203mm	#7362 203mm
#7353 254mm	#7363 254mm
#7354 305mm	#7364 305mm



Examples of projects made easier with pre-drilled acrylic rods.

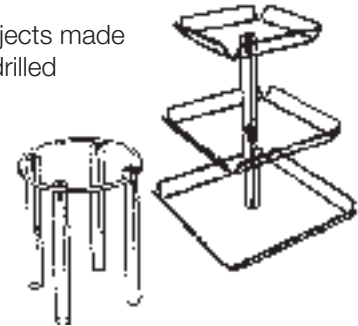

## SQUARE ACRYLIC BASE

150mm square base injection moulded in clear acrylic with stub to take #7509 acrylic tubing (see pg B1).

#7145



## FLANGE

Injection moulded heavy-duty polycarbonate flange to take 25mm dia tubing or rod. Overall dia. 61mm It has 4 off 6mm dia holes on 50mm PCD. Incorporates a grub screw for tightening onto the tubing/rod.

#7549



## PANEL CONNECTORS

Panel Connectors allow for the connection of panels of glass, acrylic or other panel material up to 5mm thick. Simple tightening of nylon grub screw allows for quick assembly and disassembly.

### TWO-WAY CHROME



#0670

### THREE-WAY CHROME



#0671

### FOUR-WAY CHROME



#0672

### TWO-WAY 120° CHROME



#0673

### THREE-WAY 120° CHROME



#0674

### HINGE CHROME



#0675

### TWO-WAY HASP-CHROME



#0676 Pair of fittings.  
Works with Mini-Padlock, p8.

Our adjustable fittings are designed so that they can slide along a length of glass and support a shelf or vertical divider.

### THREE-WAY ADJUSTABLE CHROME



#0677

### FOUR-WAY ADJUSTABLE CHROME



#0678

## METAL PEG HOOKS

Our comprehensive range of display hooks provides you with a solution for hangsell merchandise in almost every situation. All our hooks can be used with pegboard or Plankwall.

### STANDARD-DUTY SINGLE HOOK-CHROME

Our most popular hook range, 3mm diameter wire, deluxe chrome finish.

- #0550 50mm
- #0551 100mm
- #0552 150mm
- #0553 200mm



### HEAVY-DUTY SINGLE HOOK - CHROME

Heavy 6mm wire prong, Deluxe chrome finish.

- #0560 100mm
- #0561 150mm
- #0562 200mm
- #0563 250mm
- #0564 300mm



### DOUBLE WIRE PEGHOOK

For slotted cards, deluxe chrome finish with solid metal backplate. Fits light and heavy duty pegboard and plankwall.

- #0830 100mm
- #0831 150mm
- #0832 200mm
- #0833 250mm
- #0834 300mm



### LOOP - TYPE HOOK

Strong 20mm wide plastic cover combined with standard duty wire hook for slotted cards, keeps products aligned without wobbling.

- #0575 100mm
- #0576 150mm
- #0577 200mm



## LABEL HOLDERS

Universal for all types of scanning hooks, Clear plastic pocket protects plain paper label.

	Label Size
#0825	50 x 26 mm
#0826	80 x 26 mm
#0826A	80 x 39 mm



## CHROME SCANNING HOOK

Medium-duty wire construction with solid backplate for 6mm pegboard or plankwall, deluxe chrome plated finish, Use in conjunction with our label holders (Purchased separately).

#0820	100mm
#0821	150mm
#0822	200mm
#0823	250mm
#0824	300mm



## GLASS - FILLED PLASTIC SCAN HOOK

Glass - filled acetal plastic gives this hook three times the strength of un-filled plastic hooks. Self locking design locks hooks onto pegboard so that it can't wobble or lift out during use. Self loading slant back design. Use in conjunction with our standard label holders (ordered separately).

#0635	100mm
#0636	150mm
#0637	200mm



## PLASTIC SCANNING HOOK

The first all-plastic scan hook system! Built in label holder for adhesive labels, two piece direct entry systems locks hooks onto pegboard so that it cant wobble or lift out during use.

#0630	50mm
#0631	100mm
#0631A	150mm





## NOSE BRIDGES

The nose bridge provides a quick and clean way to provide professional looking eyeglass displays. Glasses fit over the bridge, with arms folding behind.

## FLAT-GLUE-ON

#7334 Overall length 50mm



## ANGLED-GLUE-ON

#7335



## FLAT-PIN MOUNT

Push fit into 4.76mm dia hole on 38mm centres (vertically).  
Backplate size: 38mm wide x 50mm high.  
See other pin-mounted accessories on p10.

#7336 Overall length 80mm



## GROOVED WALL MOUNT

Grooved Wall Mount - one piece molded design fits grooved wall or slot in up to 6mm thick back panel.

#0247 Length 50mm  
#0243 Length 80mm



## ROD MOUNT ATTACHMENTS

The following range of components is designed to clip to any 16mm dia rod or tube (apart from the solvent-bonded nose bridge). See Page 20 for 16mm acrylic rods available in either clear or frosted.

### GLUE ON NOSE BRIDGE

Shaped to solvent bond onto rod.

#7333

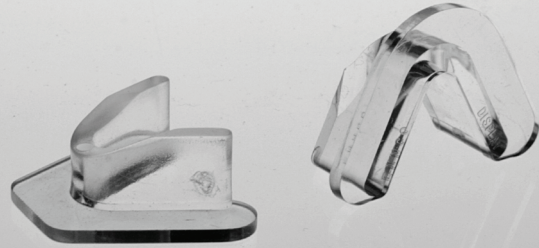

### SPECTACLE ROD CLIP - STRAIGHT

Shaped to solvent bond onto rod.

#7331 Clear polycarbonate. Overall length - 93mm

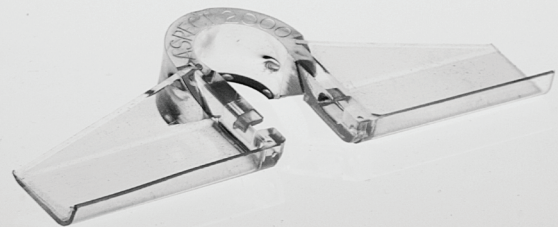

### SPECTACLE ROD CLIP - FOR CURVED SUNGLASSES

Shaped to solvent bond onto rod.

#7330 Clear polycarbonate. Overall length - 67mm

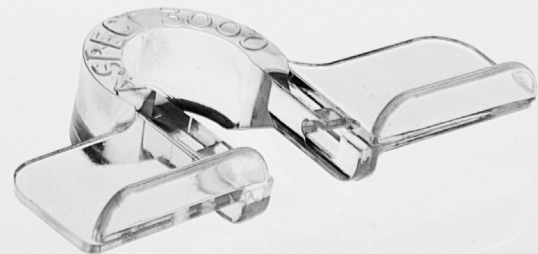

### GROOVED WALL CLIP

For supporting bent acrylic rods on to grooved wall system. Rod snaps securely in place.

#0246 Overall length 50mm



### ROD ATTACHMENT

With centre screw hole - for mounting 16mm dia rod either horizontally or vertically.

#7332 Clear polycarbonate. Overall length - 24mm

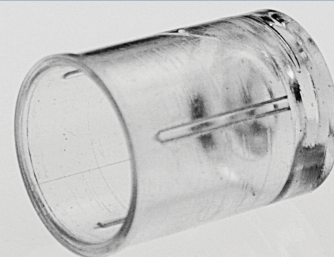

### COLLAR

Glue to back of brochure pocket, sign holder or whatever you wish, then clip to rod. Also allows for countersunk screw slot.

#7328 Overall length 32mm

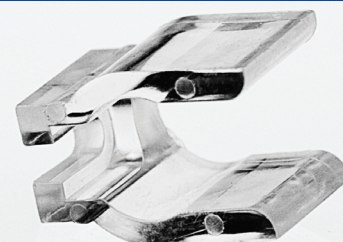

## WATCH DISPLAY CLIP

This convenient clip is available with a number of different mounting options to make creative jewellery displays.

### GLUE TO 12.7mm ROD

#7338

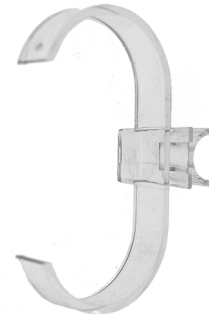

### GLUE TO BACKING

#7339



### PUSH FIT INTO 4.75MM DIA HOLE

#7340



### GROOVED WALL MOUNT

#0231



## PLASTIC HOOKS

This new range of injection-moulded plastic hooks provides a strong but lightweight solution to the needs of visual merchandisers in many applications. Our new Auto-Insertion hooks will even make their own holes in cardboard displays, providing unlimited merchandising freedom in this application. All hooks are available in WHITE – other colours (including clear) can be ordered, subject to minimum quantities and lead times.

## PEGBOARD HOOK

Single		Double	
#0770	50mm	#0775	50mm
#0771	100mm	#0776	100mm
#0772	150mm	#0777	150mm
#0773	200mm	#0778	200mm

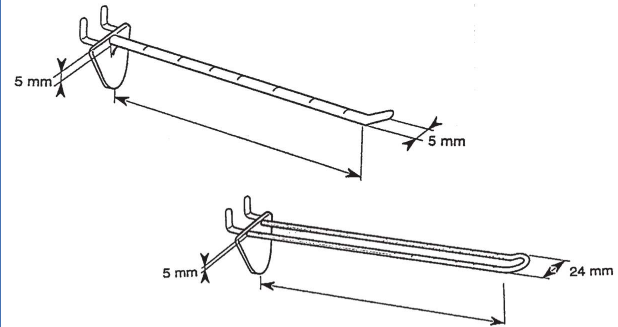

## PLANKWALL HOOK

Single		Double	
#0785	50mm	#0790	50mm
#0786	100mm	#0791	100mm
#0787	150mm	#0792	150mm
#0788	200mm	#0793	200mm

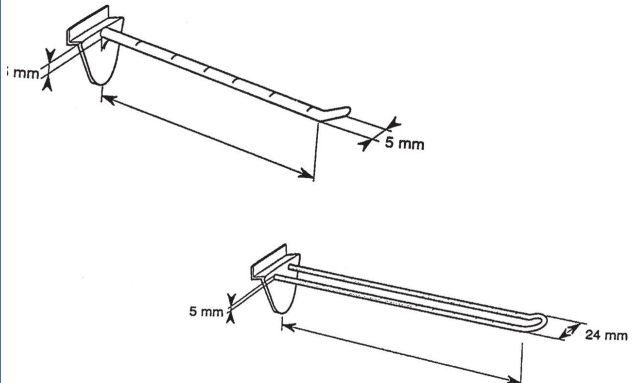

## AUTO-INSERTION HOOK

Single		Double	
#0750	50mm	#0755	50mm
#0751	100mm	#0756	100mm
#0752	150mm	#0757	150mm
#0753	200mm	#0758	200mm

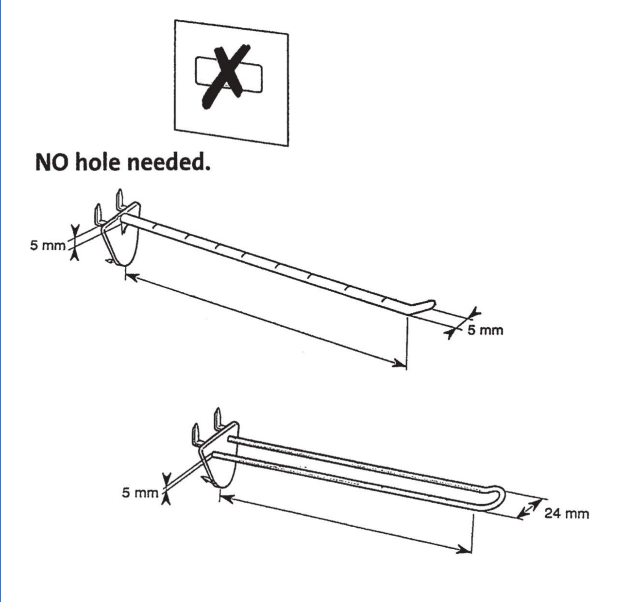

**1**  
Pierce the cardboard display with the sharp points of the hook.



**2**  
Push down on the hook to allow the lower barb to pierce the cardboard.



**3**  
Your hook is now secure and ready to merchandise.

# B

## EXTRUDED PLASTIC SECTIONS

<b>ACRYLIC TUBE &amp; ROD .....</b>	<b>20</b>
<b>ACRYLIC SECTIONS .....</b>	<b>21</b>
<b>CLEAR BUTYRATE PROFILES.....</b>	<b>23</b>
<b>PLASTIC SHELF STANDS .....</b>	<b>24</b>

We stock the largest range of extruded sections available for a range of fabrication industries including POP displays, laboratory fixtures, novelty items, furniture, etc..

## ROUND ACRYLIC TUBING

Sold in 1830mm lengths.

	Inside Dia.	Outside Dia.	Wall Thickness
#7503	12.7mm	19.0mm	3.2mm
#7504	9.5mm	15.9mm	3.2mm
#7505	9.5mm	12.7mm	1.6mm
#7506	12.7mm	15.9mm	1.6mm
#7507	15.9mm	19.0mm	1.6mm
#7508	15.9mm	22.2mm	3.2mm
#7509	19.0mm	25.4mm	3.2mm
#7510	25.4mm	31.7mm	3.2mm
#7515	31.7mm	38.1mm	3.2mm
#7516	38.1mm	44.5mm	3.2mm
#7517	44.5mm	50.8mm	3.2mm
#7518	50.8mm	57.1mm	3.2mm
#7519	57.1mm	63.5mm	3.2mm
#7521	63.5mm	69.8mm	3.2mm
#7520	69.8mm	76.1mm	3.2mm
#7522	82.5mm	88.9mm	3.2mm
#7525	95.2mm	101.6mm	3.2mm
#7530	120.6mm	127.2mm	3.2mm
#7535	146mm	152.4mm	3.2mm

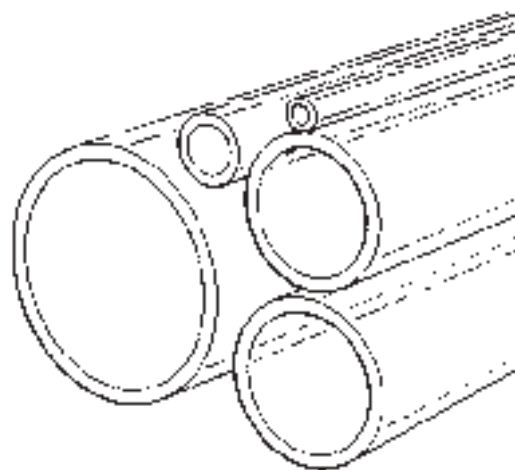

## ROUND ACRYLIC ROD

Sold in 1830mm lengths.

	Dia.
#7536	6.25mm
#7537	8.00mm
#7538	9.50mm
#7539	12.70mm
#7540	15.90mm
#7545	25.40mm
#7546	38.10mm
#7547	50.80mm

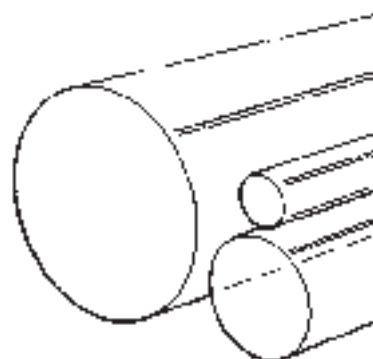

## SQUARE ACRYLIC ROD

Sold in 1830mm lengths.

	Sides
#7570	3.2mm
#7571	4.75mm
#7572	6.25mm
#7573	9.5mm

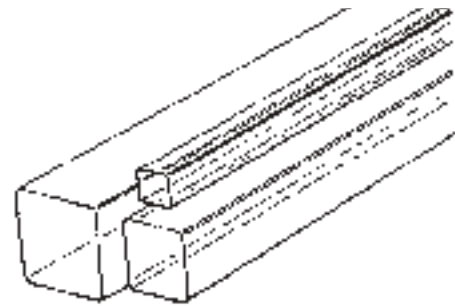

## RIGHT-ANGLE TRIANGLE ROD

Used for reinforcing of solvent bonded joints.

1830mm lengths.

	Sides
#7580	6.25mm
#7581	12.7mm

2000mm lengths.

	Sides
#7576	4mm

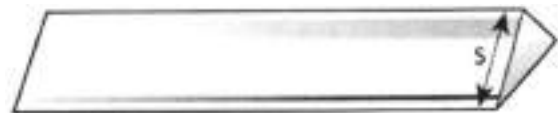

## SQUARE ACRYLIC TUBE

Sold in 1830mm lengths

	Outside dim.	Wall Thickness
#7590	25.4mm	1.6mm
#7591	50.8mm	3.2mm

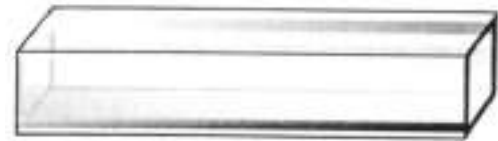

## W-BAR

For horizontal shelves, etc.. for Plankwall displays. Available in clear acrylic or DR acrylic for extra strength and easier glueing. Sold in 1830mm lengths.

#7610	Standard Acrylic
#7611	DR Acrylic

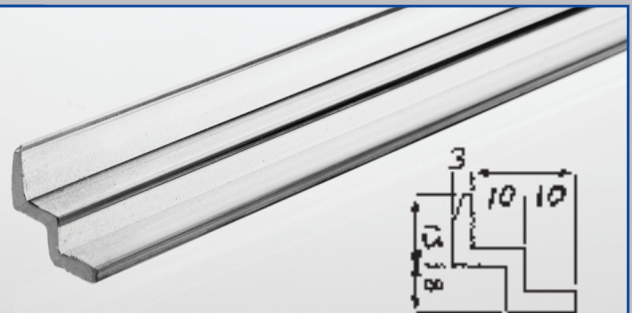

## Z-BAR

Popular acrylic extrusion for creating Plankwall display products with vertical glueing surface. Available in clear acrylic or DR acrylic. Sold in 1830mm lengths.

#7615	Standard Acrylic
#7617	DR Acrylic



## ACRYLIC J BAR

Used to create displays for earring cards or display hooks  
See page 10 for available hooks. Sold in 1830mm lengths.

#7601

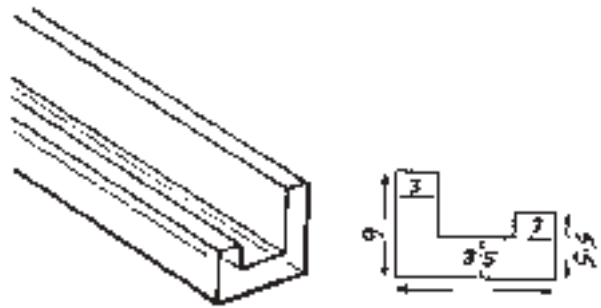

## SMALL DISPLAY J BAR

Attaches to displays to facilitate mounting to wire grid panels. Sold in 2440mm lengths.

#7603



## LARGE DISPLAY J BAR

Excellent for creating eyewear displays.  
Sold in 910mm lengths.

#7604

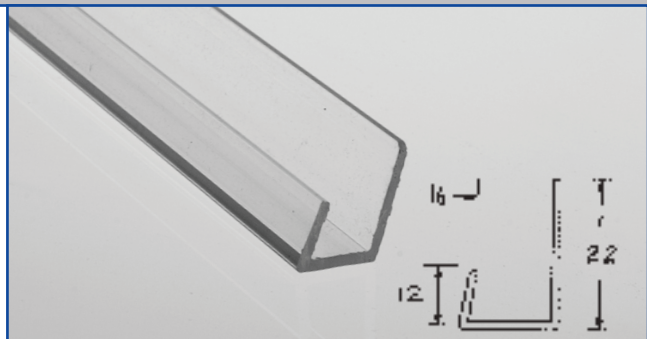

## ACRYLIC STEP STRIP

For gluing to backboard and creating sliding message panels. Sold in 1830mm lengths.

#7605 Recommended sliding panel thickness - 2mm

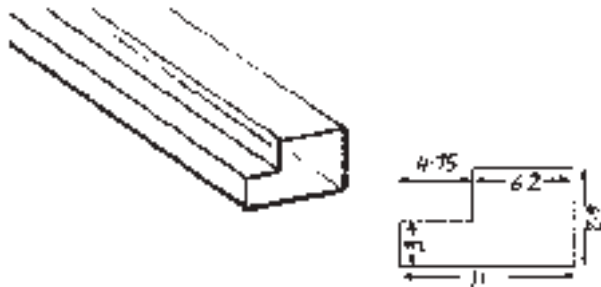

## INTERCHANGEABLE SIGNAGE BARS

Used to make multi-track changeable signs in any width you need. Allows for sliding panel thickness up to 4.5mm. Sold in 2440mm lengths.

#7606 L Bar  
#7607 T Bar

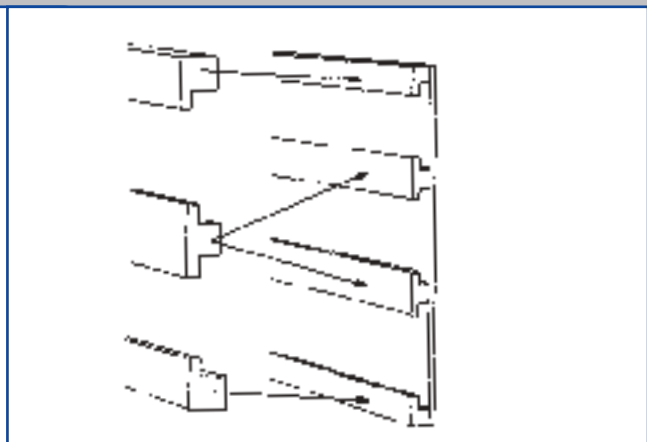
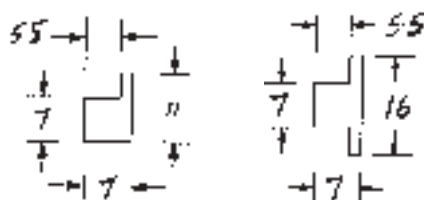



## RECTANGULAR ACRYLIC BAR

Sold in 1830mm lengths.

	Size
#7620	3.2mm x 9.5mm
#7621	3.2mm x 15.9mm
#7622	4.7mm x 19mm
#7625	6.25mm x 25.4mm

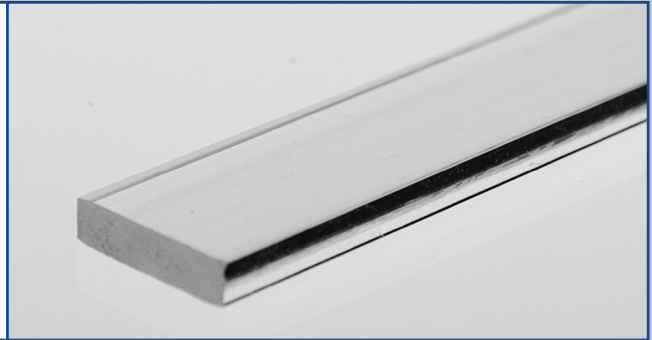

## BUTYRATE PROFILES

The following extrusions are produced from clear butyrate material which can be solvent-bonded to acrylic. Sold in 2440mm lengths.

### Endcap Moulding - Clear

- #7805 to suit 3mm thick material
- #7807 to suit 6mm thick material

### Divider Moulding - Clear

- #7810 to suit 3mm thick material
- #7812 to suit 6mm thick material

### 'U' Channel Moulding - Clear

- #7801 to suit 6mm thick material
- #7803 to suit 10mm thick material

### Angle Moulding - Clear

- #7815 12mm x 12mm
- #7817 25mm x 25mm

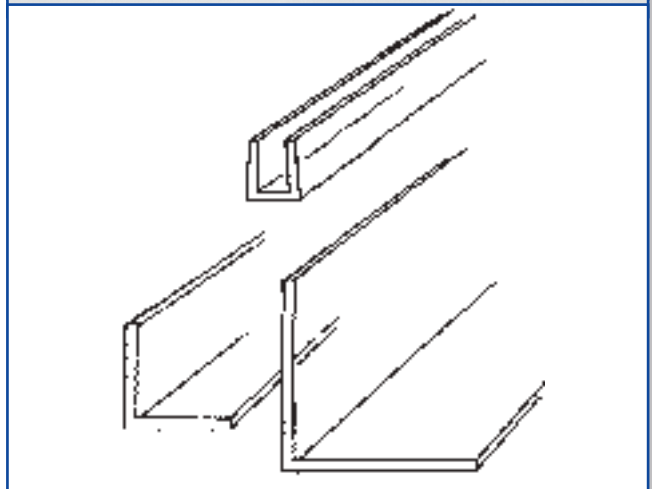
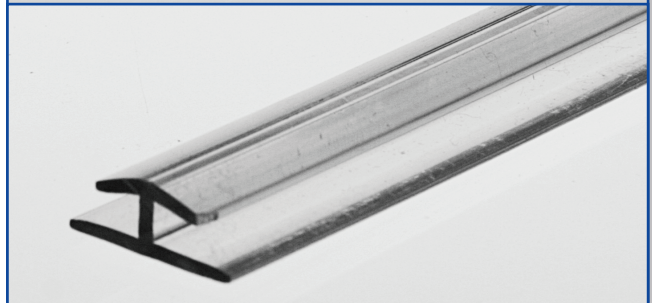
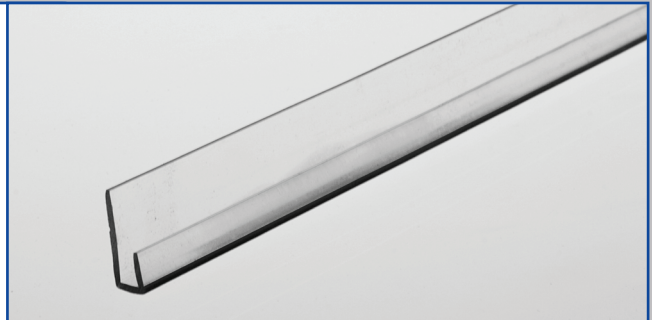

## SIGNAGE EXTRUSION

Designed for supporting signage panels 2 -4 mm thick on an 8mm dia. rod. Their uses include glass edge "softener". Material - clear PVC.

- #4472 2440mm long

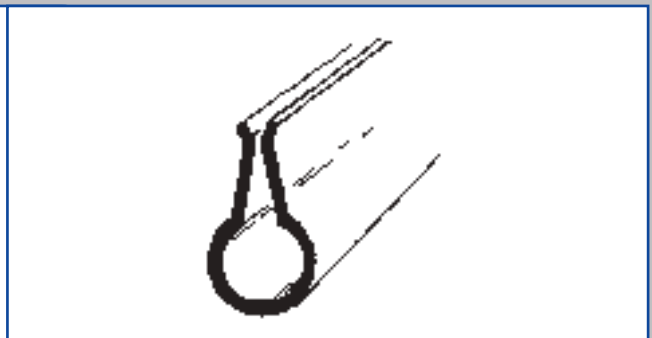

- \* We provide you with the basic shelf unit to transform into a fully branded display for your client.
- \* Shelf units come fully packaged in their own kit for simple distribution.
- \* Each unit comes complete with header card that for signage applications.

## STANDARD SHELF

Shelf size - 550 x 360mm. White injection moulded shelves with clear PVC space tubes. Includes header card in screen-printable foamed

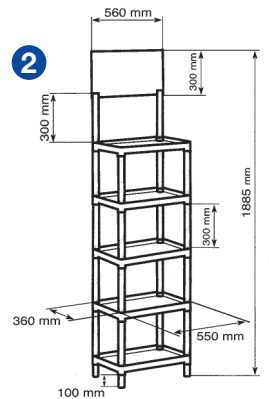

Overall height  
(including header card)

- ① #1484 4-shelf unit – 1785mm
- ② #1485 5-shelf unit – 1885mm

## MAXI-SHELF

Shelf size – 790 x 510mm. Super strength white injection-moulded shelves with clear polycarbonate spacer tubes. Includes header card in screen-printable foamed PVC sheet – 800mm(w) x 400mm(h)

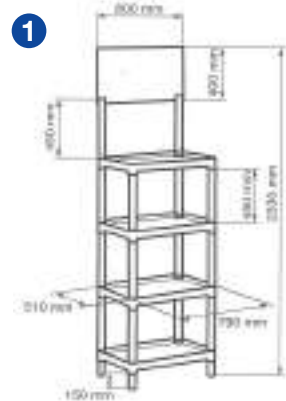

Overall height  
(including header card)

- ① #1494 4-shelf unit – 2330mm
- ② #1495 5-shelf unit – 2525mm

# C

## HAND TOOLS, ADHESIVES & CLEANING

<b>FABRICATION MANUAL . . . . .</b>	<b>26</b>
<b>MANUAL CUTTERS &amp; EDGE SCRAPERS . . . . .</b>	<b>26</b>
<b>DRILL BITS . . . . .</b>	<b>27</b>
<b>ADHESIVES . . . . .</b>	<b>28</b>
<b>ADHESIVE APPLICATORS . . . . .</b>	<b>29</b>
<b>CLEANING CLOTHS . . . . .</b>	<b>30</b>
<b>CLEANERS . . . . .</b>	<b>30</b>
<b>BUFFING WHEELS &amp; COMPOUNDS . . . . .</b>	<b>31</b>
<b>SCRATCH REMOVERS . . . . .</b>	<b>32</b>
<b>PLASTIC REPAIR KITS . . . . .</b>	<b>33</b>
<b>MINI-FLUORO LIGHTING SYSTEM . . . . .</b>	<b>34</b>

## FABRICATION MANUAL

A fully illustrated 48-page manual for the intermediate and advanced craftsman working with acrylics. Includes sections on bending, cutting, sawing, shaping, moulding, polishing and more.

#7415



## PLASTICUTTERS

Specially designed blade scores and cuts acrylic and other plastics up to 6mm thick. The position and the angle of the hardened steel cutting edge is the key to its ability to cut. Blades fold into handle for safe storage, but snaps in place when opened. An excellent tool for field work.

#7265 Standard Duty  
#7268 Heavy Duty



## EDGE SCRAPER

This unique four-function tool prepares edges for buffing or flame polishing. This easy grip tool removes saw cuts and sharp corners, bevels thick materials (up to 10mm) and will radius edges (up to 6mm thick).

#7269



## CERAMIC SCRAPER

Use for scraping flat surfaces and also for bevelling and radius edges. These quick and handy tools make it easy to deburr holes and curves of any size. The amazing ceramic technology provides unsurpassed ease of use and finished product.

① #7275 Ceramic Scraper - small  
② #7276 Ceramic Scraper - large



## DRILL BITS

Specially manufactured to produce smooth holes in acrylic. The special tip angle allows for gradual penetration of material, thus eliminating damage to back side of material. Modified rake angle of 10° and cutting edge of 10° produces smooth chip-free hole when working with acrylics.

#7251-03	3.18mm (1/8")	#7251-14	14.3mm (9/16")
#7251-04	4.0mm (5/32")	#7251-16	15.9mm (5/8")
#7251-05	4.76mm (3/16")	#7251-17	17.5mm (11/16")
#7251-06	6.25mm (1/4")	#7251-19	19.05mm (3/4")
#7251-07	7.14mm (9/32")	#7251-21	20.63mm (13/16")
#7251-08	8.0mm (5/16")	#7251-22	22.2mm (7/8")
#7251-10	9.5mm (3/8")	#7251-24	23.8mm (15/16")
#7251-11	1.1mm (7/16")	#7251-25	25.4mm (1")
#7251-12	12.7mm(1/2")		



## DRILL SETS WITH CASE

#7255	7pc set - 1/8" - 1/2" by 1/16ths
#7256	29pc set - 1/16" - 1/2" by 1/64ths
#7257	37pc set - 1/16" - 1"
#7258	8 pc set - 9/16" - 1" by 1/16ths



## DOUBLE-SIDED PAPER TAPE

High performance, medium tack adhesive tape for template routing. Can be used several times before needing replacement. Leaves no residue.

#0795	19mm wide x 33mtr long
-------	------------------------

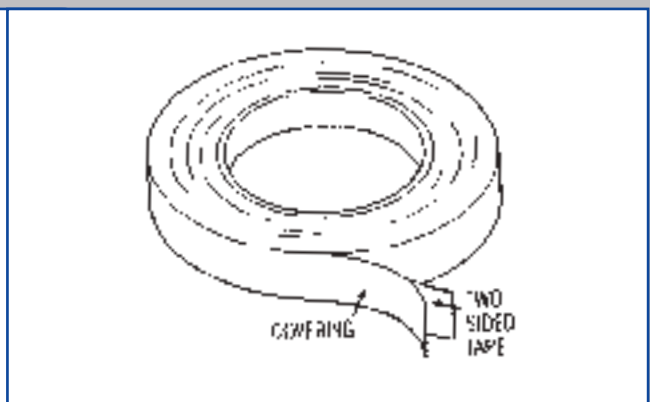

## ACRI-BOND 105

Clear, fast-curing, water-thin solvent cement ideal for joining uncross-linked cast and extruded acrylic, polycarbonate and ABS. Also suitable for many other applications (see chart). Provides instant initial bonding which makes it ideal for T-bonds and narrow areas of all kinds. Recommended application by brush, syringe or needle applicator.



- #7215 500ml sealed metal can (includes 1 x pouring spout for every 2 cans)
- #7216 4.0L sealed metal can with pouring spout.

SELECTION CHART	ACRYLIC	PC	HIPS	ABS	PVC	PETG
ACRYLIC	●					
PC POLYCARBONATE	●	●				
HIPS HIGH IMPACT POLYSTYRENE		●	●			
ABS ACRYLONITRILE BUTADIENE STYRENE	●	●		●		
PVC (Sheets, Foams) POLY VINYL CHLORIDE						
PETG POLY ETHYLENE TEREPHTHALATE						●

## ACRI-BOND 110

Clear, thickened acrylic cement for use with most commonly used plastic materials. In various combinations. It leaves a clear finish on all materials and provides very strong bonding. Fast-drying, initial bond is firm within a short time. Leaves approximately 30% solid residue after drying.



- #7221 100ml tube with nozzle.
- #7220 500ml sealed metal can (includes 1 x pouring spout for every 2 cans)
- #7222 4.0L sealed metal can with pouring spout.

SELECTION CHART	ACRYLIC	POLYCARB	HIPS	ABS	PVC	PETG
ACRYLIC	●					
PC POLYCARBONATE	●	●				
HIPS HIGH IMPACT POLYSTYRENE	●	●	●			
ABS ACRYLONITRILE BUTADIENE STYRENE	●	●	●	●		
PVC (Sheets, Foams) POLY VINYL CHLORIDE	●			●	●	
PETG POLY ETHYLENE TEREPHTHALATE						

## ACRI-BOND 120

Clear, fast-curing, water-thin solvent cement ideal for joining ABS, HIPS & PETG. One-part adhesive that provides very strong bonding and a clear finish. Recommended application by brush, syringe or needle applicator.



- #7225 500ml sealed metal can (includes 1 x pouring spout for every 2 cans)
- #7226 4.0L sealed metal can with pouring spout.

SELECTION CHART	ACRYLIC	POLYCARB	HIPS	ABS	PVC	PETG
ACRYLIC						
PC POLYCARBONATE	●	●				
HIPS HIGH IMPACT POLYSTYRENE	●	●	●			
ABS ACRYLONITRILE BUTADIENE STYRENE	●	●		●		
PVC (Sheets, Foams) POLY VINYL CHLORIDE	●	●			●	
PETG POLY ETHYLENE TEREPHTHALATE		●			●	●

## ACRI-BOND 125

Clear, thickened acrylic cement that can provide virtually bubble-free joining and lamination of acrylic to acrylic, polycarbonate HIPS, ABS & PVC. It leaves a clear finish and provides very strong bonding.



- #7230 500ml sealed metal can (includes 1 x pouring spout for every 2 cans)
- #7231 4.0L sealed metal can with pouring spout.

SELECTION CHART	ACRYLIC	POLYCARB	HIPS	ABS	PVC	PETG
ACRYLIC	●					
PC POLYCARBONATE	●	●				
HIPS HIGH IMPACT POLYSTYRENE	●	●	●			
ABS ACRYLONITRILE BUTADIENE STYRENE	●	●		●		
PVC (Sheets, Foams) POLY VINYL CHLORIDE	●	●		●	●	
PETG POLY ETHYLENE TEREPHTHALATE	●			●		

Our glue bottles and syringes are the choice for bonding acrylics and other plastics using the capillary method. For best results, assemble parts to be glued in their final positions, then apply a thin line of solvent cement along the edge where the parts meet. The cement will run into the joint and bond evenly and smoothly.

## GLUE BOTTLES

The oval squeeze bottle is the most popular tool for applying solvent cement. Simply squeeze some air out of the partially filled bottle before inserting to avoid drips, and you'll have an even, controlled flow. Glue bottles are designed for easy needle replacement in case of clogging.

**#7084** 55ml bottle with lid for interchangeable needles



## SYRINGE

The syringe applicator gives the same even capillary control as the oval glue bottle but also offers better control for hard to reach places. Easy to fill and replace needles.

**#7094** 30ml Syringe



## NEEDLE

The larger the needle gauge, the smaller the needle diameter. The smallest is the 27 gauge which gives fine flow control. The 25 gauge needle is the most popular choice for many fabricators. For production applications, some fabricators prefer the 22 gauge needle for faster solvent flow. The 16 gauge needle allows for the use of thickened adhesives.

<b>#7070</b> 20 Gauge	<b>#7072</b> 25 gauge
<b>#7071</b> 22 gauge	<b>#7077</b> 27 gauge
<b>#7073</b> 16 gauge	



## FUNNEL

This small funnel makes filling glue bottles neat and easy.

**#7080**

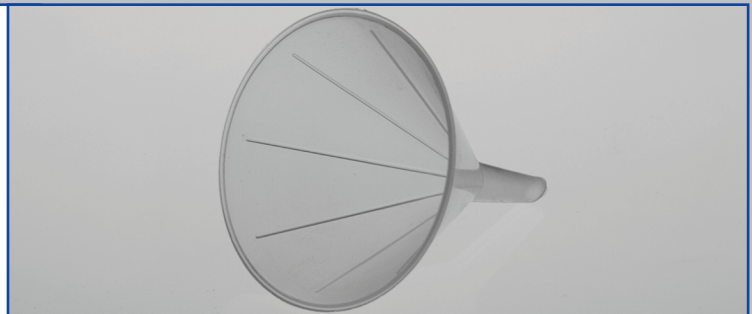

## "WITCH HAT" APPLICATOR

Easy to use and re-fill this "squeezie" bottle allows for the application of thickened cements.

**#7081**

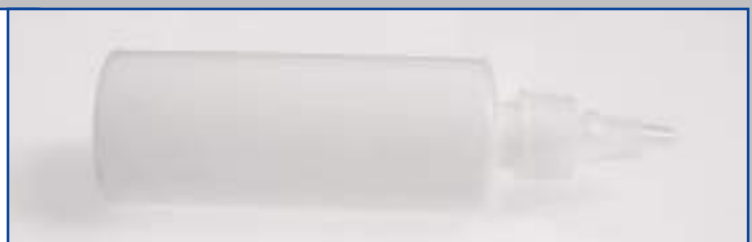

## BRILLIANIZE

Specially formulated to clean acrylic and other plastic surfaces without scratching or hazing. Contains anti-static to resist fingerprints and dust. Certified non-toxic, no skin or eye irritant

- #7052 250ml Spray
- #7051 4 Litre



## COTTON GLOVES

Greatly reduces clean up time by eliminating fingerprints on fabricated parts. Available in men's or women's sizes. Sold by the dozen pairs.

- #7053 Men's - sold per dozen pairs
- #7054 Ladies - sold per dozen pairs



## POLISH MATE CLOTHS

Don't use the wrong cloth to clean plastic surfaces!!! Eliminate scratching with the Polish-Mate cloths that offer cloth-like softness in a disposable wipe. They are highly absorbent, abrasion resistant, low-lint and extra durable.

#7067



## SPLIT MICRO FIBRE CLOTHS

Microfibre is a man made product that contains 2 basic fibres - polyester and polyamide, producing fibres with a thickness less than a human hair that have been split 16 times into a "V" shape. The fibres are then woven into fabric of 80% polyester (the scrubbing and cleaning fibre) and 20% polyamide (the absorbing and quick drying fibre)

The benefits of split micro fibre cloth is that the surface area of the cloth is increased by over 15 times creating millions of crevices which trap and hold water and debris. Split microfibre cloths are re-usable, machine wash with laundry detergent or hand wash with dish soap in hot water. Do not use bleach or fabric softeners. Air dry



- #7059 (aqua) For final polishing - also excellent for spectacles, CD's, camera lenses, LCD Screens

### ERC - MicroFiber

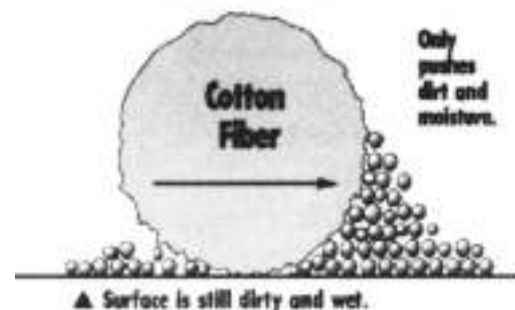



## ACRI-BOND CLEANER

Clear, water-thin, fast evaporating, solvent-based cleaner developed for acrylic. Also good for other plastic materials such as polycarbonate, HIPS & ABS. Test before use. Apply to clean cloth and wipe gently. Change cloth sides regularly to avoid scratching surface.

#7241 4.0L sealed metal can



## ACRI-BOND MASKREM

Clear, water-thin, slow evaporating, non-hazardous cleaner developed for removing stubborn masking paper or residue from acrylic. Also good for other plastic materials such as polycarbonate, HIPS & ABS. Test before use. Apply liberally over residue to be removed. Leave until soaked, then scrape or remove paper or tape. To remove remaining residue, apply to cleaning cloth and wipe gently. Use ACRI-BOND CLEANER for final touches.

#7242 1.0L sealed metal can



## TUFBUF LAMBSWOOL PADS

Superior quality pure lambswool buffing pads with hook and loop backing plate to attach to a foam pad for drill attachment or with variable speed polishers. Choose from 12 or 20 nap.

### 12mm nap

#7450 125mm diameter

#7451 180mm diameter

### 20mm nap

#7455 125mm diameter

#7456 180mm diameter

## MACHINE BUFFING WHEELS

Loose layered buff wheels can be stacked together for a wider working area.

#7460 200mm, 60ply Arbor size 16mm

#7461 250mm, 60 ply Arbor size 25mm

## CONCENTRIC STITCHED BUFFING WHEEL

Eliminate the hard spot that spiral stitched buffs have.

#7465 250mm, 40 ply Arbor size 25mm

## BUFFING COMPOUND

Three different grade bars available for polishing acrylics and other plastics with a buffing wheel. All bars measure approx. 260mm long x 65 x 50 mm.

### Basic Finish Compound

#7271 for course fast buffing  
Red Tripoli

### Final Finish Compound

#7272 Blue rouge



## MICRO FINISH

Final polishing liquid to remove any residual haze. Use to brighten and obtain pristine finish.

- #7083 55ml
- #7085 225ml
- #7086 4.5L

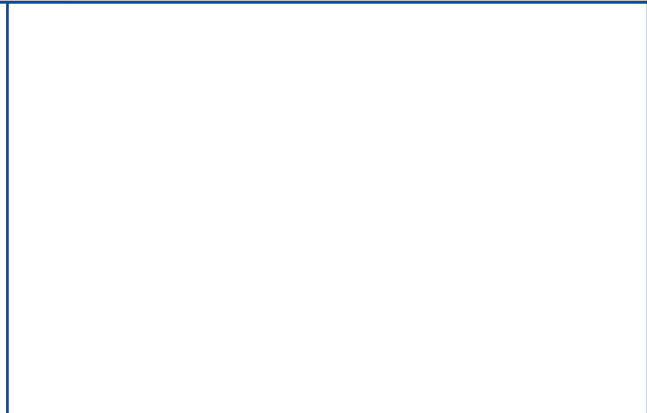

## ANTI-STATIC CREAM

The liquid contains a protectant and is designed to remove static electricity that could cause dirt and dust to be drawn back to your newly polished surface.

- #7087 55ml
- #7088 225ml
- #7089 4.5L

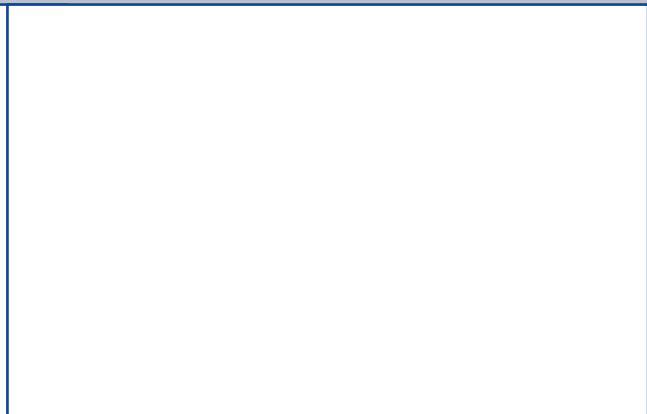

## FLANNEL CLOTH

100% flannel cloth recommended when using Micro Gloss liquid abrasives. Size 300 x 275mm

#7055

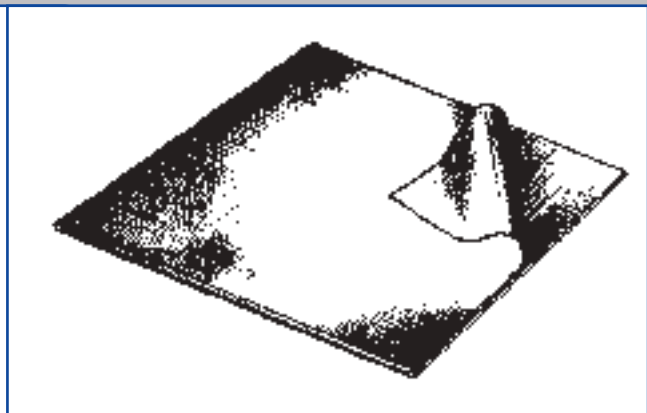

## MICRO GLOSS

A general all purpose water based liquid abrasive which uses either a one micron or five micron aluminum oxide crystal to achieve a fine finish on acrylics, polycarbonates, paints lacquers, fiberglass etc...

This unique liquid removes hairline scratches, haziners and halos untouched by other products. Approved as safe for use on the inside and outside surfaces of F16 aircraft. Used by hand or machine with lambswool polishing pad (Micro Gloss will not remove any damage that can be felt by a fanger nail).

- |                        |       |  |       |
|------------------------|-------|--|-------|
| <b>Micro Gloss # 1</b> |       | <b>Micro Gloss #5</b> for heavier applications |       |
| #7064                  | 55ml  | #7074  | 55ml  |
| #7065                  | 225ml | #7075  | 225ml |
| #7066                  | 4.5L  | #7076  | 4.5L  |



## MICRO-MESH™

Micro- Mesh™ is available in a wide range of belts, tapes, discs - Velcro grip or adhesive backed to suit many different polishing applications. Display Components now stocks the following repair kits for mechanical or hand operation. All kits come with detailed step by step instructions.

## ACRYLIC RESTORAL KITS

The most popular kit - will restore up to 3 square metres of material. Kit includes:

- #7155**
- 1 - 150 x 75 sheet 1500
  - 1 - 150 x 75 sheet 1800
  - 1 - 150 x 75 sheet 2400
  - 1 - 150 x 75 sheet 3600
  - 1 - 150 x 75 sheet 4000
  - 1 - 150 x 75 sheet 6000
  - 1 Micro Gloss - 55ml
  - 1 - 75mmsq Foam Block
  - 2 - 300mmsq Flannel Cloth

- #7156**
- 2 - 150 x 75 sheet 1500
  - 2 - 150 x 75 sheet 1800
  - 2 - 150 x 75 sheet 2400
  - 2 - 150 x 75 sheet 3600
  - 2 - 150 x 75 sheet 4000
  - 2 - 150 x 75 sheet 6000
  - 2 Micro Gloss - 55ml
  - 1 75mmsq Foam Block
  - 2 300mmsq Flannel Cloth

- #7157**
- 1 - 300 x 150 sheet 1500
  - 1 - 300 x 150 sheet 1800
  - 1 - 300 x 150 sheet 2400
  - 1 - 300 x 150 sheet 3200
  - 1 - 300 x 150 sheet 3600
  - 1 - 300 x 150 sheet 4000
  - 1 - 300 x 150 sheet 6000
  - 1 - 300 x 150 sheet 8000
  - 1 - 300 x 150 sheet 12000
  - 1 - 75mmsq Foam Block
  - 1 - Bottle Anti-Static Cream
  - 2 - 300mmsq Flannel Cloth



### Here are some basic guidelines on how to repair damaged acrylic and restore to new appearance:

#### Crazing

A series of very fine I lines, stars or haze when viewed at an angle in bright light. Crazing is below the surface and usually cannot be felt with the fingernail. Requires aggressive sanding to remove. Begin with 220 grit wet/dry sandpaper.

#### Deep Scratches

Easily felt with the fingertip. Begin with 220 grit wet/dry sandpaper.

#### Minor Scratches

Readily detected with fingernail. Begin with 1500 Micro-Mesh. If the scratch is not easily removed use 400 wet/dry sandpaper followed by Micro-Mesh 1500.

#### Hairline Scratches & Light Scuffs

Light scratches and hazing - Begin with 2400 or 3600 Micro-Mesh.

#### Very Fine Scratches

Usually caused by improper cleaning methods. Begin with 4000 or 6000 Micro-Mesh.

# "MINI-FLUORO" LIGHTING SYSTEM

## "MINI-FLUORO" LIGHTING SYSTEM

The "Mini-Fluoro" lighting system offers an excellent energy-saving method of illumination in small spaces, recesses and cove lighting applications.

These fittings are fully assembled with built-in electronic ballast and linkable by means of standard connectors, saving you time while eliminating the need for qualified electricians to wire up.

High quality construction for long life in commercial applications.

## "MINI-FLUORO" FITTING

Low profile design – only 23mm wide x 40mm high. Fitting includes T5 fluorescent tube in Tri-phosphor Cool Daylight colour. Optional polycarbonate diffuser cover available.



\* Unit includes stainless steel mounting clips for easy installation.

Unit without diffuser	Unit including diffuser	Nom. Length	Wattage	Max. No. Linkable
#7950/2	#7955/2	600mm	14W	12
#7950/3	#7955/3	900mm	21W	8
#7950/4	#7955/4	1200mm	28W	6
#7950/5	#7955/5	1500mm	35W	4

## MAINS CABLE

1800mm long lead with standard 2-pin plug and fitting on other end to attach to fluoro.



#7968

## DIRECT CONNECT

Attaches 2 x fluoros end to end.



#7960

## VERTICAL GLASS CLIP

Fits panels up to 8mm thickness. Colour – white



#7966 – 80mm  
#7964 – 250mm  
#7962 – 500mm

# D

## CABLE & ROD DISPLAY SYSTEM

<b>FLOOR-CEILING KITS</b> .....	<b>36</b>
<b>WALL-MOUNTED CABLE KITS</b> .....	<b>37</b>
<b>1.5mm CABLE FITTINGS</b> .....	<b>38</b>
<b>ACRYLIC GRAPHIC PANELS</b> .....	<b>39</b>
<b>3mm CABLE FITTINGS</b> .....	<b>40</b>
<b>6mm ROD FITTINGS</b> .....	<b>40</b>
<b>WALL-MOUNTED ROD FITTING</b> .....	<b>40</b>
<b>WALL-MOUNTED PANEL FITTINGS</b> .....	<b>41</b>
<b>HANGING KITS</b> .....	<b>42</b>
<b>COMPONENTS</b> .....	<b>44</b>

Durable kits provide the solution for any display situation from the common “floor to ceiling” configuration to various wall-mounted applications. (Numbers relate to individual components that are available separately - see p.44 for item numbers).

## 1.5mm Cable



**#1800** - Kit includes 3.6mtr length of stainless steel cable.

**#1800L** - Kit includes 5mtr length of stainless steel cable.

- Cables are fitted with top bulb that eliminates any possibility of cable pulling through.
- The strength of the cable installation depends on the ceiling being able to take the weight.

## 3mm Cable



3mm thick cable provides extra stability to the cable display with less movement between fittings.

**#1840** - Kit includes 5mtr length of stainless steel cable.

## 6mm Rod



Ideal where extra rigidity is required. 6mm chrome plated steel rod comes in 1.0 meter lengths that can be joined together and trimmed to make up the exact length.

**#1900** - Floor - Ceiling fittings (Rod purchased separately).

**#1910** - 6mm dia chrome rod- 1.0mtr length. e.g. for 2.6 metre height you would need to order 1 x 1900 and 3 x 1910 to give you 1 vertical.

## MOUNTING TRACK

Aluminium extrusion with sliding fittings that allows for lateral adjustment of individual vertical cables and rods. May be recessed into board to make flush fitting.

- #8852** Mill Finish aluminium - length 4.0mtrs
- #8852A** Anodized aluminium - length 4.0mtrs
- #1826** Threaded plate and screw (set consists of 1 plate and 1 screw)



Our wall-mounted cable kits all utilize 1.5mm diameter stainless steel cable. (Numbers relate to individual components that are available separately - see p.44 for item numbers).

## WALL-WALL POSTER KIT

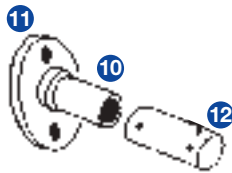

**#1802** - Designed to display vertical panels 45mm from wall (mount wall fittings pull cable through bottom wall spacer and tension with pliers, then tighten up with grub screws).

## WALL-FLOOR POSTER KIT

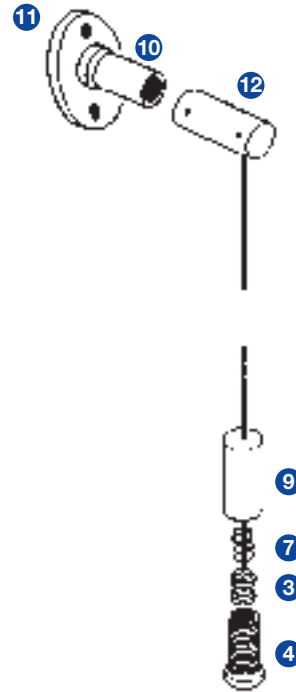

**#1801**

## WALL-WALL SHELF KIT



**#1806** - Designed for shelving, panels etc. Rod extends 260mm from wall. Minimum shelf width 215mm (when used horizontally)

## WALL-FLOOR SHELF KIT

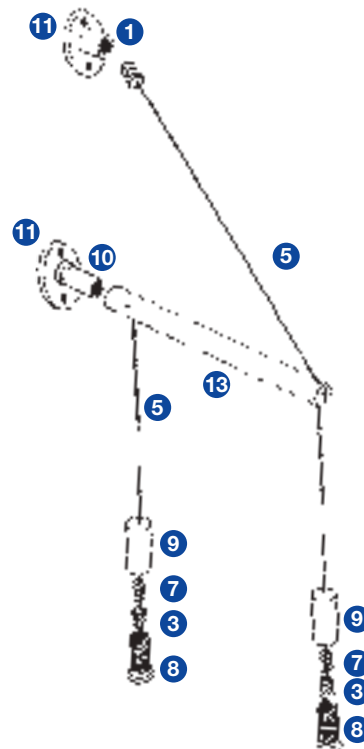

**#1805**

# 1.5mm CABLE FITTINGS

## CABLE FASTENER

Attaches to cable with M4 thread through centre.  
Used for attaching panels/cabinets to cables.

**20mm Diameter x 13mm Long**  
**#1812** Anodized Aluminium



## THROUGH-HOLE SHELF SUPPORT

Requires 9mm dia. hole in shelf.  
Can be used with any thickness material.



A 2mm wide slot from the centre of the hole to edge of the shelf will allow the shelf to be removed without altering the cable.

**20mm Diameter x 15mm High**  
**#1811** Anodized Aluminium



## SINGLE FITTING

Swivel fitting allows for mounting of flat or sloping shelves or vertical display panels.

**20mm Diameter x 30mm Long**  
**Anodized Aluminium**

- #1813** to suit panel thickness up to 4mm
- #1817** to suit panel thickness up to 7mm
- #1819** to suit panel thickness up to 10mm



## DOUBLE FITTING

Swivel fitting allows for mounting of flat or sloping shelves or vertical display panels.

**20mm Diameter x 45mm Long**  
**Anodized Aluminium**

- #1823** to suit panel thickness up to 4mm
- #1827** to suit panel thickness up to 7mm
- #1829** to suit panel thickness up to 10mm



## MINI PANEL FITTINGS

Our new mini fittings allow for mounting vertical panels in a single or double sided configuration. Slimmer profile makes fitting less obtrusive. Will take up to 4mm thick panel.

- #1898** Single sided - Anodized aluminum. Size 15mm dia x 30mm long
- #1899** Double sided- Anodized aluminum Size 15mm dia x 45mm long





# ACRYLIC GRAPHIC PANELS

- Folded clear acrylic sandwich panels for a comprehensive solution for interchangeable displays
- Easy access pockets allow for changing of the poster without touching the panel fittings.
- Any combination of pockets with the same cable spacing can be used in the same vertical drop.

## SINGLE POCKETS

Clear acrylic.

		*Cable Spacing (mm)
#1881P	A4 Portrait	265
#1881L	A4 Landscape	355
#1885P	A3 Portrait	355
#1885L	A3 Landscape	490
#1892P	A2 Portrait	490
#1892L	A2 Landscape	670
#1891P	A1 Portrait	670
#1891L	A1 Landscape	895
#1890P	A0 Portrait	895

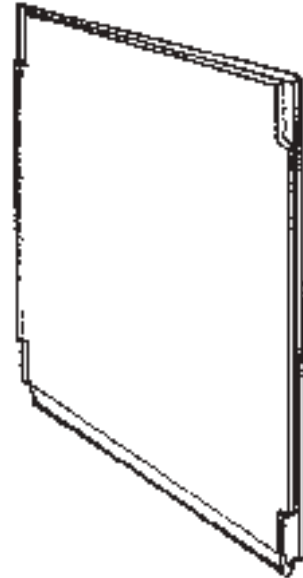

## MULTIPLE POCKETS

An economical alternative that reduces the number of cables and fittings required.

		*Cable Spacing (mm)
#1882P	Double A4 Portrait	490
#1882L	Double A4 Landscape	670
#1883P	Triple A4 Portrait	715
#1886P	Double A3 Portrait	670

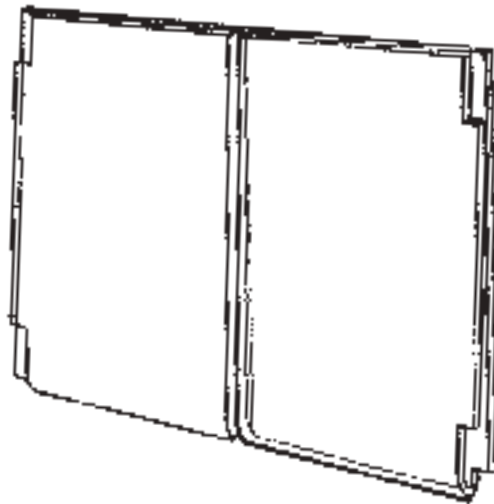

\* Actual panel width is 25mm less than cable spacing.

# 3mm CABLE & 6mm ROD FITTINGS

## 3mm CABLE FASTENER

Attaches to cable  
M4 thread through centre.  
Size: 20mm dia. x 13mm long.



#1842

## 6mm ROD FASTENER

Attaches various furniture items to rod, has M4 thread through centre. Size: 20mm dia. x 16mm long.



#1912

## 3mm THROUGH-HOLE SHELF SUPPORT

Requires 9mm dia. hole in shelf. Can be used with any thickness material. Size: 20mm dia. x 15mm high.



#1841

## 6mm ROD SINGLE FITTING

Swivel fitting allows for mounting of flat or sloping shelves or vertical display panels. Size: 20mm dia x 33mm long.



- #1913 To suit panel thickness of 3mm.
- #1917 To suit panel thickness of 7mm.
- #1919 To suit panel thickness of 10mm.

## 3mm SINGLE FITTING

Swivel fitting allows for mounting of flat or vertical shelves or vertical display panels. Size - 20mm dia. x 30mm long.



- #1843 To suit panel thickness of 3mm.
- #1846 To suit panel thickness of 7mm.
- #1848 To suit panel thickness of 10mm.

## 6mm ROD DOUBLE FITTING

Swivel fitting supports shelves etc, on either side of a central cable. Size: 20mm dia x 48mm long.



- #1923 To suit panel thickness of 3mm.
- #1927 To suit panel thickness of 7mm.
- #1929 To suit panel thickness of 10mm.

## 3mm DOUBLE FITTING

Swivel fitting supports shelves etc., on either side of central cable. Size - 20mm dia. x 40mm long.



- #1844 To suit panel thickness of 3mm.
- #1847 To suit panel thickness of 7mm.
- #1849 To suit panel thickness of 10mm.

## WALL-MOUNT ROD FITTING

Rod-wall-mount fitting.  
Priced each.



#1835

# WALL-MOUNT FITTINGS

## THROUGH HOLE PANEL FITTING

Requires 14mm dia. hole in panel. Fittings may be mixed and matched to provide the desired combination of wall spacing and panel thickness. All fittings are 20mm dia. Finished - anodised aluminium.

### Barrels

- A #1858** Length, ie. gap from wall - 25mm
- B #1861** Length, ie. gap from wall - 45mm

### Screws

- C #1856** to suit max. panel thickness - 16mm
- D #1859** to suit max. panel thickness - 10mm

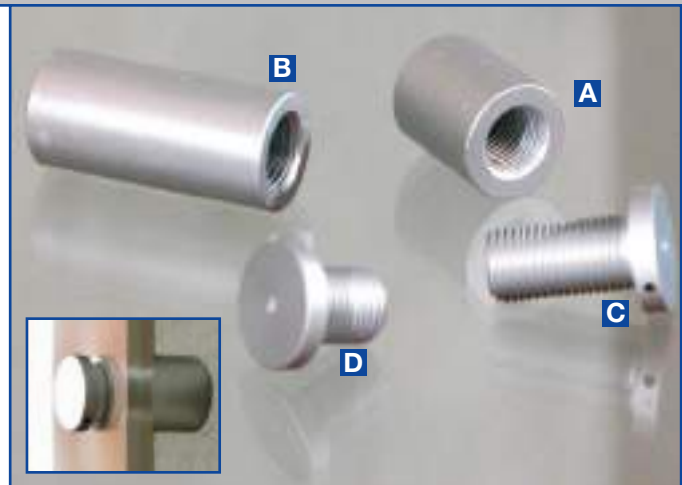

## EDGE GRIP PANEL HOLDER

Simply tighten onto the edges of your panel at the top, bottom or side. Attach to wall through the centre of the shaft, slide panel fixing on and tighten grub screws. All fittings are 20mm dia. Finish - anodised aluminium.

- #1831** Max. Panel thickness - 10mm  
Gap from wall - 25mm
- #1832** Max. Panel thickness - 4mm  
Gap from wall - 25mm
- #1835** Max. Panel thickness - 7mm  
Gap from wall - 45mm



## PANEL SUPPORTS

Can be mounted in virtually any position for mounting small shelves or signage panels at any angle. Size - 20mm dia x 16mm long O/A

- #1833** to suit panel thickness up to 4mm
- #1837** to suit panel thickness up to 7mm
- #1839** to suit panel thickness up to 10mm



## PANEL SUPPORTS

For attaching to framework – flat design for attaching to flat surface, or concave design for attaching to round tubes. Includes M8 bolt for attaching to threaded holes or with nut for attaching to structures where back is accessible.

Variable fastening for panels 10 – 18mm thick.  
Size – 46mm deep x 40mm high. Finish – Chrome



- 1 #1965** Flat back surface
- 2 #1966** Concave back surface

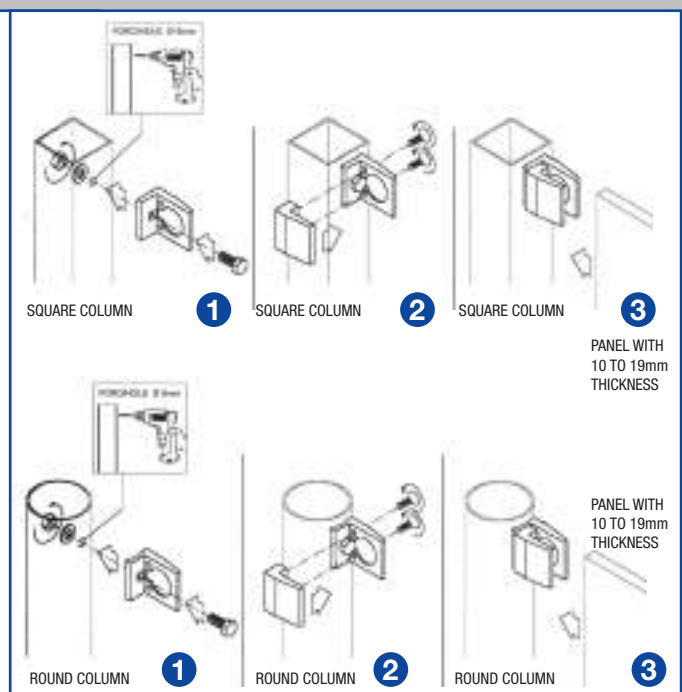

## HANGING KIT

**#1950**

2 piece screw on fixing.

**#1951**

1 metre cable with ball end.



## SWIVEL MOUNTING BRACKET

**#1961**

For attaching picture frames etc.



## CABLE HANG KITS

Select the kit according to the thickness panel you are suspending.

**#1803** to suit 3mm panel thickness

**#1807** to suit 7mm panel thickness

**#1809** to suit 10mm panel thickness

Priced individually - i.e. you will need 2 kits to suspend 1 sign.



## ROD HANG KITS

**#1840**

Includes 2 x ceiling fittings and 2 x chrome plated steel rods - 500mm long  
(Rod fittings to hold panel supplied separately).

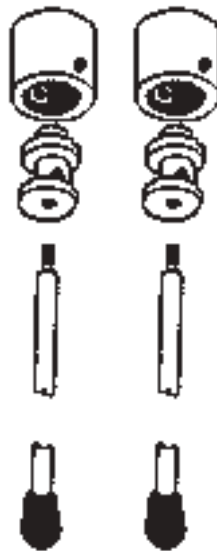

## PICTURE HANGING SYSTEM

The aluminum track is fixed to the wall at the desired height or onto the ceiling. The swivel fitting simply slides in the end of the track to the desired location. Set the Slide-Lock hook fitting to the desired height by pushing the button and your artwork is now ready to hang. The system allows for infinite adjustment with no tools required. Additional hook fittings are available to hang more than one picture in a vertical drop.



**Additional Hook Fitting  
#1971**

### Aluminium Track #8852

4 metre length.  
Available in Mill Finish (M)  
or Anodised (A).

Top swivel fitting in  
aluminium track.



### Hanging Kit

Includes swivel top fitting  
with cable and 1 x AUTO  
hook fitting that can be  
adjusted at the push of a  
button.

**#1970**  
900mm cable.

**#1972**  
2000mm cable.



## THROUGH HOLE PANEL FITTING

High quality polished chrome finish.  
Diameter – 20mm  
Distance (wall to back of panel) - 54mm  
Max. panel thickness - 10mm  
Hole diameter for mounting – 6.5mm

**#1955**



## THROUGH HOLE PANEL FITTING

High quality polished chrome finish. Component design  
allows for different display combinations, including multi-  
layered panels.  
Diameter – 30mm  
Max. panel thickness - 25mm  
Hole diameter for mounting – 7mm

Each set contains the following components:

- ① Wall-mount flange x 2 off
- ② Threaded distance spacer
- ③ Threaded rod
- ④ Fastening cover

	Distance (wall to back of panel)
<b>#1967</b>	30mm
<b>#1968</b>	57mm
<b>#1969</b>	95mm



## TOP MOUNT

Size - 20mm dia.

- 1 #1853 20mm long
- 2 #1854 30mm long



## CABLE GRIPPER

Size 10mm dia x 14mm long.

- 3 #1850 1.5mm cable
- 4 #1852 3mm cable



## STAINLESS STEEL BALE

With fixed bulb fitting.  
Length 3.6 mtr

- 5 #1876 1.5mm dia
- 6 #1873 3mm dia



## SPRING

- 7 #1877



## FLOOR FIXING

Size - 20mm dia x 30 mm long.

- 8 #1855



## TENSIONING SLEEVE

Size 20mm dia x 45mm long.

- 9 #1860



## WALL SPIGGOT

Size - 20mm dia.

- 10 #1857



## WALL FLANGE

Size 55 x 32 mm with  
3/16" threaded centre hole.

- 11 #1865



## WALL CABLE SPACER

Size - 20mm dia. x 55mm long  
(fits onto Wall Spiggot)

- 12 #1870



## EXTENSION ARM

Size 20mm dia x 250mm long  
(fits onto Wall Spiggot)

- 13 #1871



## ROD GRIPPER

Size - 10mm dia. x 55mm long  
(has M4 thread through centre)

- 14 #1851



## ROD GRIP

Size 10mm dia x 10mm long  
material - mild steel.

- 15 #1862



## ROD TENSIONING SLEEVE

Size - 20mm dia. x 45mm long

- 16 #1861



## ALLEN KEYS

- #1816 2mm for cable kits
- #1810 3mm for cable fittings
- #1818 4mm for rod fittings



## HANGING FITTING

Size - 20mm dia. x 30mm long 2mm  
dia hole one end M4 thread other end.

- #1803BTM 4mm
- #1807BTM 7mm
- #1809BTM 10mm



# E

## BROCHURE & INFORMATION HOLDERS

<b>BUSINESS CARD HOLDERS . . . . .</b>	<b>46</b>
<b>DL BROCHURE HOLDERS . . . . .</b>	<b>46</b>
<b>MULTI-BROCHURE HOLDERS . . . . .</b>	<b>47</b>
<b>A5 BROCHURE HOLDERS . . . . .</b>	<b>48</b>
<b>BROCHURE HOLDER ACCESSORIES . . . . .</b>	<b>48</b>
<b>A4 BROCHURE HOLDERS . . . . .</b>	<b>49</b>
<b>WALL-MOUNTED BROCHURE SYSTEMS . . . . .</b>	<b>50</b>
<b>CAROUSEL BROCHURE HOLDERS . . . . .</b>	<b>51</b>
<b>ACRYLIC INFORMATION HOLDERS . . . . .</b>	<b>53</b>
<b>ECONOMY BROCHURE HOLDERS . . . . .</b>	<b>54</b>

## BUSINESS CARD HOLDERS

### SINGLE POCKET COUNTER



Landscape  
93mm (W) x 18mm (D)  
**AP1501**

Portrait  
56mm (W) x 18mm (D)  
**AP1504**

### SINGLE POCKET WALL-MOUNT



Landscape  
93mm (W) x 18mm (D)  
**AP1503**

### 4 COMPARTMENT



Landscape  
4/93mm (W) x 18mm (D)  
**AP1502**

### 8 COMPARTMENT



Landscape  
8/93mm (W) x 18mm (D)  
**AP1512**

## 1/3 A4 PORTRAIT COUNTER STANDS

### SINGLE



104mm (W) x 32mm (D)  
**AP1505**

### DOUBLE (SIDE BY SIDE)



2/112mm (W) x 32mm (D)  
Also suits DL size  
**AP1506**

### 2 COMPARTMENT (HIGH BLACK)



2/110mm (W) x 32mm (D)  
**AP1518**

### 3 COMPARTMENT



3/110mm (W) x 32mm (D)  
**AP1527**

### 4 COMPARTMENT



4/104mm (W) x 32mm (D)  
**AP1507**

### 3 COMPARTMENT (SIDE BY SIDE)



3/110mm (W) x 32mm (D)  
**AP1597**

All dimensions given are internal pocket dimensions.



## FLAT PACK COUNTER STAND

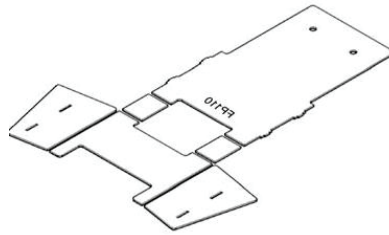
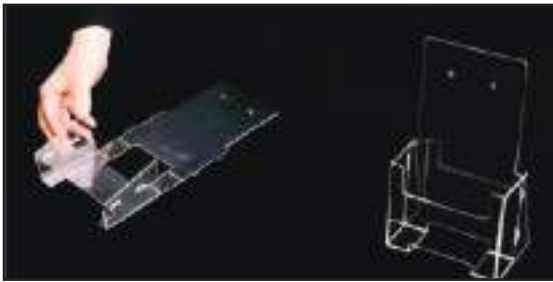

Ideal for temporary displays, exhibitions etc. Back leg folds in to allow stand to pack flat.

110mm (W) x 32mm (D)

**AP1513**

## 1/3 A4 PORTRAIT WALL MOUNT

SINGLE



104mm (W) x 32mm (D)

**AP1508**

SINGLE



110mm (W) x 32mm (D)

Also suits DL size.

**AP1508A**

3 COMPARTMENT (SIDE BY SIDE)



3/108mm (W) x 32mm (D)

**AP1599**

4 COMPARTMENT (SIDE BY SIDE)



4/104mm (W) x 32mm (D)

**AP1509**

## 1/3 A4 LANDSCAPE

COUNTER



230mm (W) x 32mm (D)

**AP1510**

WALL MOUNT



230mm (W) x 32mm (D)

**AP1511**

## MULTI BROCHURE HOLDER



4 compartment A4 landscape size - for counter or wall mount. Optional dividers allow for conversion to pocket sizes A4, A5 & DL.

4/330mm (W) x 32mm (D)

**AP1590**

Snap in divider  
Purchase separately.

**AP1591**

All dimensions given are internal pocket dimensions.

## A5 COUNTER STANDS

SINGLE



160mm (W) x 32mm (D)  
**AP1515**

2 COMPARTMENT



2/160mm (W) x 32mm (D)  
**AP1514**

2 COMPARTMENT (SIDE BY SIDE)



2/160mm (W) x 32mm (D)  
**AP1595**

3 COMPARTMENT



3/160mm (W) x 32mm (D)  
**AP1514A**

4 COMPARTMENT



4/160mm (W) x 32mm (D)  
**AP1516**

6 COMPARTMENT REVOLVING



6/160mm (W) x 32mm (D)  
**AP1578**

## A5 WALL MOUNT

SINGLE



160mm (W) x 32mm (D)  
**AP1517**

DOUBLE (SIDE BY SIDE)



2/162mm (W) x 32mm (D)  
**AP1596**

## BROCHURE HOLDER ACCESSORIES

CLIP ON STAND

Attaches to wall mount units to allow them to free-stand.



**AP1530**



Use with AP1508, AP1508A, AP1509, AP1517, AP1522



HOOK OVER CLIP

Attaches to wall mount units to attach them to aluminium wall strip or attach to each other.

**AP1531**

All dimensions given are internal pocket dimensions.

## A4 COUNTER STANDS

SINGLE



230mm (W) x 32mm (D)  
**AP1520**

3 COMPARTMENT



3/230mm (W) x 32mm (D)  
**AP1521**

4 COMPARTMENT



4/430mm (W) x 32mm (D)  
**AP1524**

6 COMPARTMENT REVOLVING



6/230mm (W) x 32mm (D)  
**AP1576**

12 COMPARTMENT REVOLVING



12/230mm (W) x 32mm (D)  
**AP1546**  
Overall height - 500mm

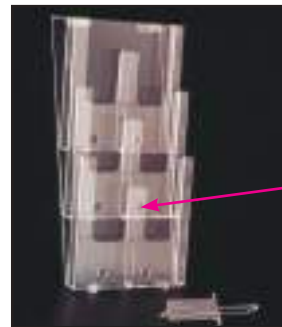

All A4 size brochure pockets can be divided into double DL pockets with the AP1533 divider  
**AP1533**

## A4 WALL MOUNT

SINGLE



230mm (W) x 32mm (D)  
**AP1522**



3 COMPARTMENT  
3/230mm (W) x 32mm (D)  
**AP1523**  
Overall height - 500mm

## A4 LANDSCAPE

SINGLE COUNTER STAND



330mm (W) x 32mm (D)  
**AP1588**

SINGLE WALL MOUNT



330mm (W) x 32mm (D)  
**AP1589**

All dimensions given are internal pocket dimensions.

## WALL-STRIP BROCHURE SYSTEM



Based on the AP1522 single A4 brochure holder, this system is supplied in a kit with all components for providing a smooth and even presentation for displaying literature on a wall surface.

**AP1528** - Complete kit for 16 x A4 brochures. Each kit contains:

- ① 1 x AP1535 - Aluminium wall strip - 950mm (L)
- ② 32 x AP1531 - Joining clips.
- ③ 4 x AP1530 - Back support brackets.
- ④ 16 x AP1522 - A4 brochure holders.
- ⑤ Purchase AP1533 dividers if required to divide pockets into double DL.

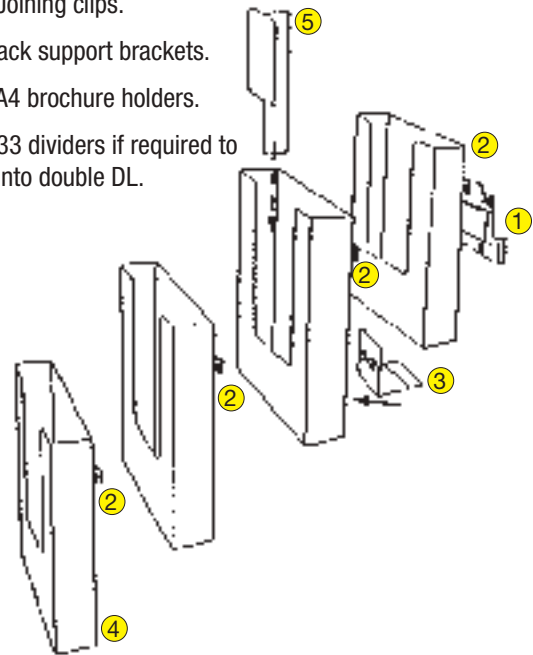

## ADJUSTABLE SYSTEM

A superb, innovative method of displaying literature, calendars and thin packaged items. Can be set up to display any size material with the added bonus that single pieces can be added on as required, with each additional element creating a 3 pocket display at less than half the cost of a standard brochure holder.

**AP1535** - Aluminium wall strip 950mm long

**AP1537** - Individual pocket clips on to aluminium wall strip



## CAROUSEL BROCHURE SYSTEM



\*The TAYMAR Carousel Brochure System is a totally free-standing system that allows you to select from a range of pocket sizes and combinations to suit your exact requirements.

\*Now even more versatile and user-friendly with individual compartments that rotate on a separate 3 or 4-sided pole sleeve.

\*Assembles in seconds – just follow these simple steps:

1. Choose your base & pole combination.
2. Select the 3 or 4-sided pole sleeves – different heights for A4 or A5/DL combinations.
3. Select the appropriate number of single pockets and slide them on to the pole sleeves.
4. Select a top signholder for a branding message, if required.

### CHROME BASE & POLE

Size - 20mm dia x 30 mm long.



**AP1551/56** 450mm dia. base & pole.  
**AP1552/56** 350mm dia. base & pole.  
 (350mm base not recommended for brochure holder application)

### METAL STAR BASE & POLE

Heavy duty fully welded construction including nylon hooded castors & 38mm chrome pole. Pole height - 1600mm overall height - 1700mm



**AP2064/46** - 600mm dia. base & pole.

### NYLON BASE & POLE

Heavy duty moulded black nylon base with 38mm pole. Pole height - 1600mm (may be cut to length).



**AP1553**  
600mm dia. base



**AP1548/49**  
500mm dia. base



**AP1555B**  
Push-in braking castor for nylon base. Order individually - 5 per base).

### SIGN HOLDER

With fitting to slide into top of 38mm chrome tubing. Acrylic sleeve chrome channel.



**AP1550L** - A4 Landscape  
**AP1550P** - A4 Portrait  
**AP1554L** - A3 Landscape  
**AP1554P** - A3 Portrait

## 4-SIDED POLE SLEEVES



#1583 A4 height (250mm)  
#1593 A5/DL height (155mm)

## 3-SIDED POLE SLEEVES



#1584 A4 height (250mm)  
#1594 A5/DL height (155mm)

## A4 POCKET (2 COMPARTMENT)

Back to back compartments.



#1574

## DL POCKET (4 COMPARTMENT)



#1570

## A5 POCKET (2 COMPARTMENT)



#1575

## POLE CLAMP

To suit 38mm dia. tube. Simply tightens onto tube for your brochure holder to revolve.



AP1540CL

## I2-COMPARTMENT DL

Designed so that top of this module rests on top of the chrome tube. This can be modified so that the unit can slide completely over pole so that you can fit 2 modules per stand. Each compartment can be divided into double width DL using AP1533 divider.



AP1545

Brochure holder module only. Order your choice of base & pole separately.

## CLEAR TRAY MERCHANDISER

Use as a complete merchandising stand with your choice of base & pole, or use individual trays in combination with brochure holders.



AP1543

Individual tray. Clear injection-moulded plastic. 450mm dia. with 40mm high lip.

## WALL-MOUNT (plain)

Clear acrylic.

	Paper Size (WxH)	
#0443/PL	148 x 210	(A5)
#0444/PL	210 x 297	(A4)
#0445/PL	297 x 420	(A3)
#0446/PL	420 x 594	(A2)
#0447/PL	594 x 840	(A1)
#0448/PL	840 x 1188	(A0)

### WITH ADHESIVE TAPE

(2 strips of clear VHB tape)

	Paper Size (WxH)	
#0443/DST	148 x 210	(A5)
#0444/DST	210 x 297	(A4)
#0445/DST	297 x 420	(A3)
#0446/DST	420 x 594	(A2)
#0447/DST	594 x 840	(A1)

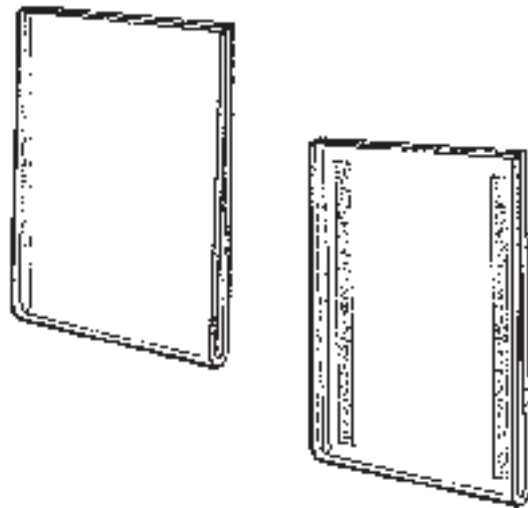

## WALL - MOUNTED (with holes)

Clear acrylic.

### PLAIN

	Paper Size (WxH)	
#0443/2H	148 x 210	(A5)
#0444/2H	210 x 297	(A4)
#0445/2H	297 x 420	(A3)
#0446/2H	420 x 594	(A2)
#0447/2H	594 x 840	(A1)



## ANGLED INFORMATION HOLDERS

Deluxe mitred corner frames with fitting to suit threaded stems.

	Paper Size (WxH)
#0400	95 x 55(Bus. card)
#0401	105 x 148(A6)
#0402	100 x 210(DL)
#0403	148 x 210(A5)
#0404	210 x 297(A4)
#0405	297 x 420(A3)



## VERTICAL INFORMATION HOLDERS

Clear acrylic.

	Paper Size (WxH)
#0411	105 x 148(A6)
#0412	100 x 210(DL)
#0413	148 x 210(A5)
#0414	210 x 297(A4)
#0415	297 x 420(A3)

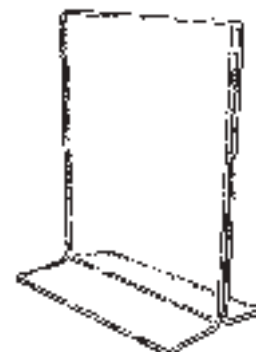

## ECONOMY BROCHURE HOLDERS

- At last, a premium quality brochure holder system with an economy price tag, the PERFECTO range meets many common applications in the marketplace.
- Injection-moulded from crystal-clear plastic that is more durable than equivalent products.
- Designed and manufactured in Europe which shows through in the flowing design and quality materials.

## DL SINGLE POCKET



**#1654** Internal size 110(w) x 37(d) x 140(h)

## A5 SINGLE POCKET



**#1655** Internal size 155(w) x 37(d) x 155(h)

## A4 SINGLE POCKET

**#1656** Internal size 235(w) x 37(d) x 245(h)

## PLANKWALL CLIP

Sold in pairs.



**#1657**

## BACK SUPPORT

Used to convert the standard wall-mount holder to free-standing.



**#1558** for DL & A5 single pockets  
**#1559** for DL & A5 single pockets

## LIGHTWEIGHT INFO HOLDERS

Poster pocket made of folded non-reflective PVC with metal rivets at top to allow for easy hanging.



**#29304** A4 portrait  
**#29303** A3 portrait  
**#29302** A2 portrait  
**#29301** A1 portrait



# F

## POSTER HOLDERS & TICKET CLIPS

SCREW-ON CEILING TRACK . . . . .	56
CEILING GRID CLIPS . . . . .	56
HANGING HOOKS . . . . .	56
JET WIRE . . . . .	57
SPRING CUP . . . . .	57
POSTER RAILS – PLASTIC . . . . .	58
ALI-INFO RAIL . . . . .	59
ALI-INFO FRAMES . . . . .	60
ALI-CLICK FRAMES . . . . .	62
FOOTPATH SIGNS . . . . .	63
DATA STRAPS . . . . .	64
TICKET CLIPS . . . . .	65
SIGNHOLDERS WITH ATTITUDE . . . . .	67

## SCREW-ON CEILING TRACK

Ideal for plasterboard ceilings or other non-grid areas. Shift sign placement left or right with ease, install parallel tracks for a 3D layered effect, eg in display windows. Remove and replace promotions in seconds. Powdercoated off-white to match ceiling.



#1767 1200mm  
#1768 2400mm



## PLASTIC CLIP

Galvanized wire hook.



#1750

## WIRE CLIP

Low Profile Galvanized wire hook.



#1751

## FISH CLIP

Virtually invisible white plastic clip for light applications.



#1753

## REGULAR HOOK

2mm galvanized wire with 16mm opening.

#1770/4 100mm  
#1770/6 150mm  
#1770/12 300mm  
#1770/18 450mm  
#1770/24 600mm  
#1770/30 750mm  
#1770/36 900mm

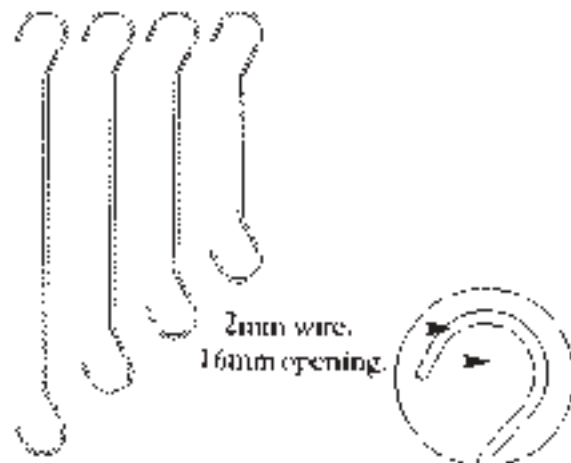

## JET-WIRE® MOBILE SPRING

Jet-Wire® is an expanding spring hook which remains in desired position when it's pulled. Can be loaded with up to 1kg in all positions. Tensile strength when completely extended up to 3,5kg. Attach Jet-Wire® to the ceiling and pull down to desired position. Hooks on foldable wire make hanging simple and fast.

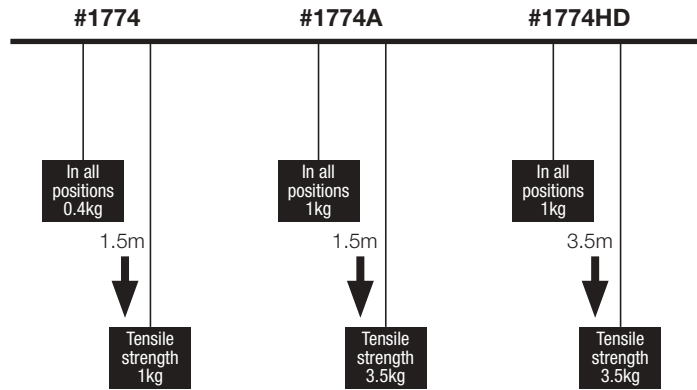

## 'S' HOOKS

Allows hanging of multiple signs or other objects in tandem.



- #1771 25mm long
- #1773 45mm long
- #1772 100mm long - heavy duty

## UNIVERSAL SPRING CLIPS

### A. Mighty Clip

50mm overall length with 10mm dia. rotating ring and spring clip. Black or White.  
#5039

### B. Super Mighty Clip

100mm overall length with 25mm dia. rotating ring and heavy duty spring clip. Black or White.  
#5033

### C. Boot Clip

120mm overall length with wire coat hanger hook and heavy duty clear plastic spring clip.  
#5034



## POSTER RAILS - PLASTIC

- In-store poster hanging has never been easier thanks to our range of poster rails that allow you to suspend graphics from thin paper to foamboards.
- Our range of ceiling-mount fittings offer fixed or variable length hooks that can be mounted onto suspended ceiling grid systems or flushed ceilings.
- Our new REEL-EASY retractable suspension fitting means that you'll never have to climb a ladder again to change signage.

## PLASTI-SLIDE

- Our lowest price sign holder.
- Sturdy yet lightweight.
- No scoring or stapling necessary.
- Simply slides on to graphic.

- #1776/3 1000mm (L)
- #1776/4 1250mm (L)
- #1776/8 2400mm (L)

Available in Clear (CL), Black (BL) or White (WH).



**AP1777**  
Hanging clip.

## PLASTIC-GRABBERS

- Our most popular sign holder.
- Easiest to use - simple snap open, insert your graphic then snap shut.
- Install and replace in seconds.
- No scoring or stapling required.

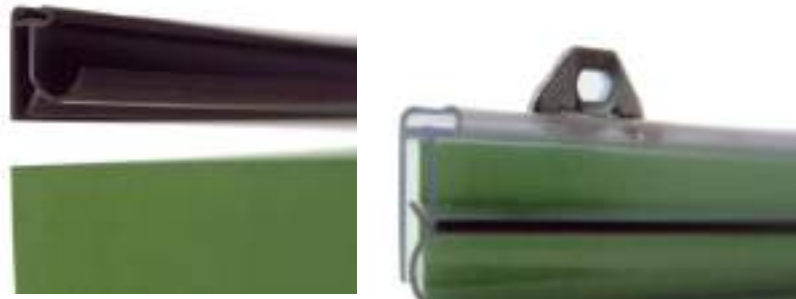

- #1780/3 1000mm (L)
- #1780/4 1200mm (L)
- #1780/8 2400mm (L)
- #1780/10 3000mm (L)

Available in Clear (CL), Black (BL) or White (WH).



### Hanging Clips

#1778  
Clear Plastic.

#1759  
Metal Clip.

# ALI-INFO RAIL

## ALI-INFO RAIL

This ALI-INFO system provides you with the most versatile signage system - a perfect combination of elegant, metallic appearance together with rigid construction that totally eliminates bowing over long lengths.

Available with accessories for a wide range of graphic materials - from thin paper, vinyl banner to 5mm thick foam board.

- #1787/3 1000mm (L)
- #1787/4 1250mm (L)
- #1787/8 2500mm (L)
- #1787/5M 5000mm (L)

Available in Clear Anodised (AN) or Polished Silver (PS).



## END CAP

Black plastic cap pushes into end to provide a finished look. When you need to change the graphic simply rotate.



- #1779 Black plastic.

## HANGING CLIPS



- 1 #1778 Clear plastic.
- 2 #1759 Pressed steel-zinc finish.

## ALI-INFO + PLASTI-SLIDE

The economy of the PLASTI-SLIDE in conjunction with the rigidity of the ALI-INFO-RAIL. Works best in semi-rigid substrates up to 2mm thick. For longer lengths you can use a number of 300mm long PLASTI-SLIDE pieces for easier attachment.



- #1789/3 1000mm (L)
- #1789/4 1250mm (L)
- #1789/8 500mm (L)

Includes 2 x end caps.  
Specify aluminium finish:  
Clear Anodised (AN) or Polished Silver (PS).

## ALI-INFO + PLASTI-GRABBER

ALI-INFO-RAIL can accept up to 4.5mm thick foam board without scoring. Use #1736 plastic rivet on rigid substrates of thinner material.



- #1792/3 1000mm (L)
- #1792/4 1250mm (L)
- #1792/8 2500mm (L)

Includes 2 x end caps.  
Specify aluminium finish:  
Clear Anodised (AN) or Polished Silver (PS).

## ALI-INFO-RAIL & SEWN BANNERS

ALI-INFO-RAIL will accept vinyl or canvas banners with a sewn pocket to take an 8mm dia. dowel.



## ALI-INFO-RAIL & RIGID SUBSTRATES

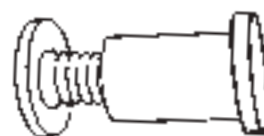

- #1736

- Drill 6mm diameter holes down 6mm (to centre)
- Push in plastic rivets from either side
- Slide into rails on inside of aluminium extrusion

# ALI-INFO-FRAME

## ALI-INFO-FRAME

More than just a great-looking frame - Ali-Info Frames are designed for maximum versatility and utmost ease of use. Able to mount almost anywhere, once assembled graphics slide in and out for quick changing. Whether you have one graphic to display or a whole programme, Ali-Info Frame provides the universal solution.

- Can be mounted to walls, windows, ceilings and floors.
- Top or side loading for easy changing.
- Choose from standard sizes or we can cut to your exact dimensions.
- Deluxe mitred corners simply push together for easy assembly.
- Choose from modern “natural anodized” finish or deluxe “polished silver”
- Designed to accept graphic panels up to 4.5mm thick.

### A) STANDARD FRAME SIZES

1. #1730/A4  
#1730/A3  
#1730/A2  
#1730/A1  
#1730/A0
2. Specify finish - Natural Anodized (AN) or Polished Silver (POL)
3. Specify - Landscape (L) or Portrait (P)
4. Specify - Top opening (T) or Side opening (S)

e.g. #1730A3ANPT (A3 sized frame in natural anodized finish, portrait with opening at top).



### B) CLEAR PLASTIC SANDWICH LABEL (optional)

Clear, thin, non-reflective PVC sleeve to protect paper graphics.

- #29250/A5
- #29240/A4
- #29230/A3
- #29220/A2
- #29210/A1

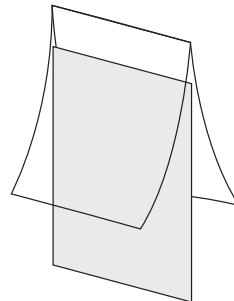

### C) METAL CORNER STAKES

(included in standard frames, also available separately)

Galvanised steel. Simple push fit into mitred frame.  
8 required per frame.

#1735

N.B Corner stakes are included in standard frame pricing.



## WALL CLIPS



#1733  
Plankwall clip.  
Use 2 clips per frame.



#1732  
Use 2 clips to hang frame  
4 clips for a more secure  
fixing. Sold individually..

# ALI-INFO-FRAME

## FLEXIBLE PVC SPLINE

Join frames at almost any angle for 3, 4 or more sided units for suspending from ceiling or free standing.

- No tools necessary - assembles in minutes
- Dramatic and affordable
- Free standing or ceiling hung applications

**#1738**  
Sold per metre.

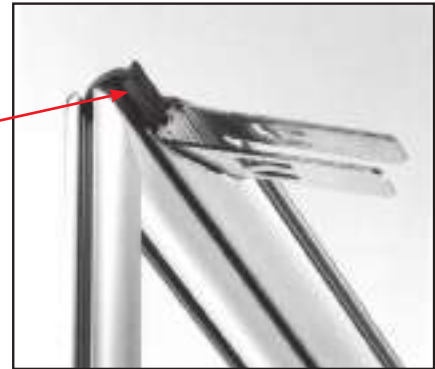
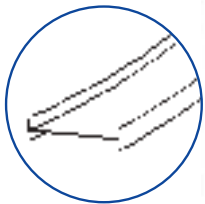

**#1793**

## PLASTIC FOOT

Secure fit snaps onto the rounded profile of the Ali-Info Frame. Provision for screwing onto flat surface.



**#1793**  
75 x 45 mm

## FRAME TOPPER CLIP

Add additional messages to your stand with Topper clips in clear plastic. Simply snap clips onto top rail of your frame and insert your graphics up to 3mm thick.



**#1689**  
Clear plastic

## STACKER BAR

Allows for stacking Ali-Info Frames as shown.



**#1752**  
Length 3050mm

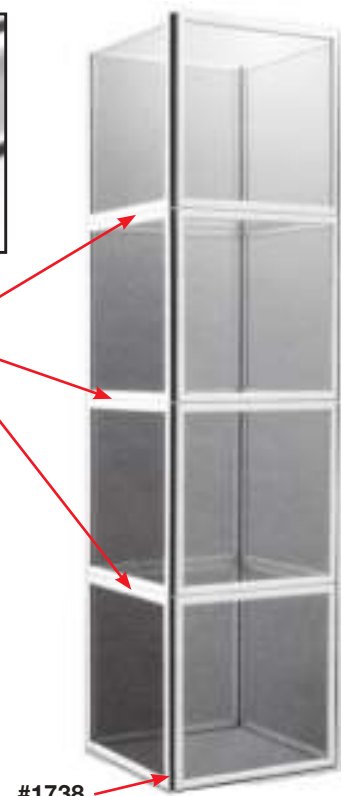

**#1738**

# ALI-CLICK FRAMES

## ALI-CLICK FRAMES

- A fully assembled, self-contained, front loading poster frame.
- Spring-loaded sides hinge independently for rapid graphic change.
- Choose from single or double-sided viewing.
- An excellent system for lightbox fronts with opal acrylic backing panel, allowing simple transparency change.
- Standard finishes available:
- Choose from the following mounting options:
  - Secure wall fix with 4 screw
  - Removable wall fix with 2 screws
  - Suction cup mounting for windows, refrigerators etc.



**A #1795**  
Back frame - Mill Finish (M) or Natural Anodised (A).

**B #1794**  
Front frame - Mill Finish (M) or Natural Anodised (A).  
May be powdercoated to your requirements

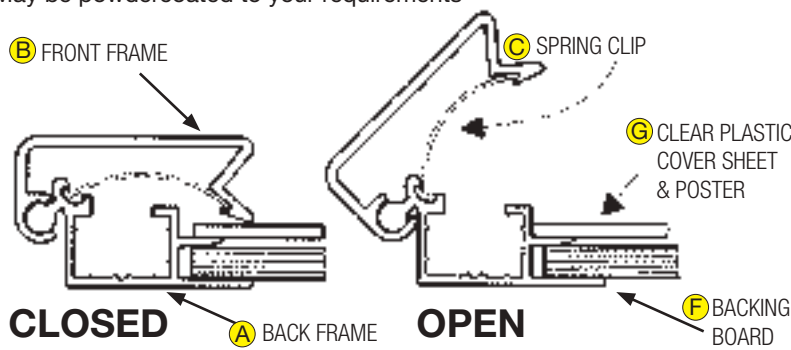

**F STANDARD BACKING BOARD**  
3mm white waterproof PVC.  
**#1739**

**G CLEAR PLASTIC COVER SHEET**  
Specify size - eg. #AP1731/A2  
**#1731**

### #1740 WALL MOUNT

- Backing board - 3mm white PVC
- Cover sheet - 1.0mm clear plastic.
- Back frame - Mill finish.
- Front frame - Natural anodised.
- Specify size - eg. #1740/A3

### #1741 HANGING OR WINDOW MOUNT

- Backing board - 3mm clear acrylic
- Cover sheet - 1.0mm clear plastic.
- Back frame - Natural anodised
- Front frame - Natural anodised.
- Specify size - eg. #1741/A2

### #1742 LIGHT BOX COVER

- Backing board - 3mm opal acrylic
- Cover sheet - 1.0mm clear plastic.
- Back frame - Mill finish
- Front frame - Natural anodised.
- Specify size - eg. #1742/A1

## C E-SPRING CLIP

Spring steel clip makes frame snap shut. Use minimum of 2 pieces per frame side.

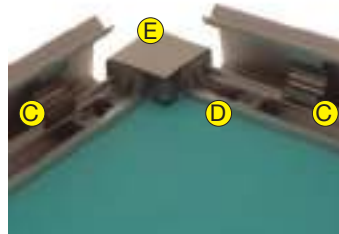

**#1799**

## D PLASTIC CORNER

Plastic moulded corner tightens onto frame with grub screws. 4 required per frame.



**#1797**  
Available in Grey (GY) or Black (BL).

## E CORNER CAP

Moulded plastic. Push fit into plastic corner.



**#1798**  
Available in Bright Chrome (C) or Satin Chrome (S).

## F SUCTION CAP ATTACHMENT

Plastic fitting clips onto the back of plastic corner and retains suction cap.



**#1744**  
Includes plastic clip & suction cap. Use 4 sets per frame



## 'ZIVA' FOOTPATH SIGN

- 70% of final purchasing decisions are made at the point of purchase. But first you have to get them into your stores.
- Taken over their lifespan, footpath signs are an extremely cost effective medium.
- Changing your advertising message to suit your current promotion, or product release, stimulates a higher level of interest resulting in increased sales.
- ZIVA Footpath Signs take A1 posters or digital prints which can be quickly and easily changed by one person.
- ZIVA Footpath Signs virtually eliminate the tripping hazard that traditional A-Frame signs present. The water weighted base prevents them being blown away in strong winds and becoming a traffic hazard.



#1705



Dark Blue



White Haze



Red



Yellow



Graphite



Designed for exterior use - completely weatherproof and UV colour fast



Water weightable base for use in exposed situations



Quickly and easily changed by one person



Wheels for easy positioning



Lockable



Suitable for use with chalkboard panels - keeps

## GRIP STRIP

Clear Butyrate - solvent bond to acrylic.  
Holds up to 1.5mm thickness.

- #0507A With adhesive tape - 150mm
- #0507/8 No adhesive - 2440mm



## DATA STRIPS

Self adhesive PVC extrusions with clear front which encloses the ticket and prevents dust being trapped in the base of the channel.

### Flat

	Length x Ticket height
#0527/26	914mm x 26mm - Clear
#0527/26BL	914mm x 26mm - Black
#0527/39	914mm x 39mm - Clear
#0528/26	1200mm x 26mm - Clear
#0528/26BL	1200mm x 26mm - Black
#0528/39	1200mm x 39mm - Clear
#0528/52	1200mm x 52mm - Clear

### Angled

Adheres to top of shelf.

	Length x Ticket height
#704/26	914mm x 26mm - Clear
#705/26	1200mm x 26mm - Clear
#705/26BL	1200mm x 26mm - Black

Other coloured backs are available to special order, subject to minimum quantities.

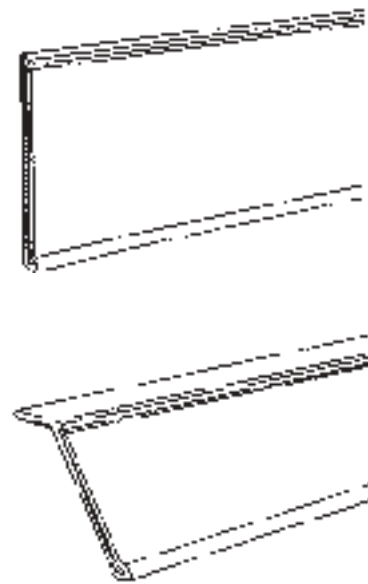

## SMALL TICKET HOLDER

Holds cards at slight angle - Clear butyrate.

#0509 32mm long



## ACRYLIC TICKET HOLDERS

Holds cards up to 300mm high - use two or more units for longer signs.

#0508 35mm (L) x 70mm (W) x 30mm (H)



## VERTICAL CARDHOLDER

With adhesive tape - hold materials up to 3mm thick. Size 45mm wide 20mm high. Material Clear butyrate.

#0513 Length 75mm  
#0514 Length 150mm



## BASKET TICKETCLIP

Clamps onto wire baskets or fencing. Ticket size - 72mm x 22mm.

#0512



## SMALL TICKET HOLDER

Clamps over 6mm thick glass shelves. Ticket size 72mm x 22mm.

#0511



## SHELF FRONT TICKET CLIP

Clamps over 6mm thick vertical fronts or dividers. Ticket size 72mm x 22mm.

#0512A



## SHELF FRONT CLIP

Clamps over 16mm - 18mm thick shelf edge.  
Ticket size 72mm x 22mm.

#0510

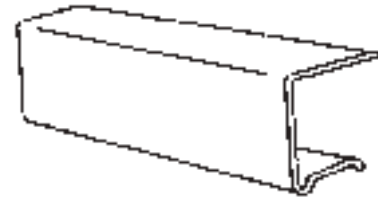

## SHELF FRONT CLIP

Clamps over 25mm thick shelf edge.  
Ticket size 72mm x 25mm.

#0510A

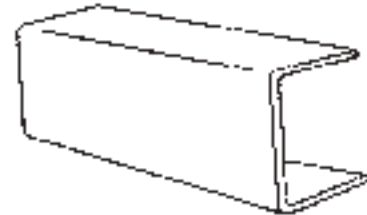

## VERSA GRIP - CLIPS AND SIGNHOLDERS

Exclusive single flexible tab design makes it easy to insert material up to 3mm thick. Clear, co-extruded PVC



## SIGNHOLDER

12mm wide base with adhesive tape.

- #0490 25mm (L)
- #0491 75mm (L)
- #0492 150mm (L)

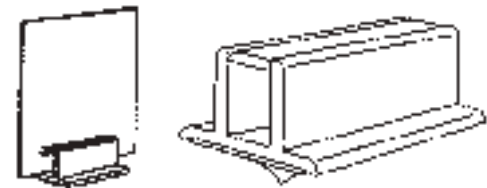

## SIGNHOLDER

With adhesive tape.

- #0487 25mm (L)
- #0489 75mm (L)



## SIGNHOLDER

32mm wide base with adhesive tape.

- #0496 25mm (L)
- #0497 75mm (L)
- #0498 150mm (L)

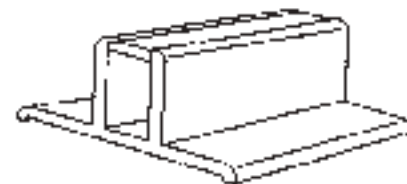

## HINGED SIGNHOLDERS

Signholder swings when bumped, then returns to the original position. Can be used vertically or horizontally with adhesive tape.

#0479 75mm



## SIGN HOLDERS WITH ATTITUDE

Now you can select from our large range of special signholders that twist & rotate, allowing an energetic display.

You can either order the individual components listed or get them assembled in the combination of your choice.

You can use 1 or more extension posts with the "knuckle" joiners to create unique sign effects.



### ROUND BASE

Clear plastic base with fitting that allows for direct connection of ball fittings or extension posts.



- #28405 50mm dia.
- #28406 80mm dia.

### RECTANGULAR BASE

Clear plastic base with fitting that allows for direct connection of ball fittings or extension posts.



- #28407 74 x 40mm

### SMALL MAGNET BASE

White plastic with ball fitting. Size – 30 x 12mm x 15mm high (+ ball)



- #28408

### ICE STICK

Clear plastic spike for poking into ice, meats, etc...



- #28415

### SPRING CLAMP

Clamps over 25mm dia. Tubing or up to 20mm thick board. With top ball fitting.



- #28424

### BOTTLE NECK BASE

Clear plastic sleeve with flexible skirt that clamps around the neck of most bottles. Allows for direct connection of ball fittings or extension posts.



- #28417

### KNUCKLE CONNECTOR & EXTENSION POSTS

White polypropylene connector that snaps onto ball ends, allowing for 360deg. Swivel.

- 1 #28420 Knuckle Connector
- 2 #28425 Clear plastic stems with ball end allow for extending the sign holder.
- 3 #28426 50mm long
- 100mm long

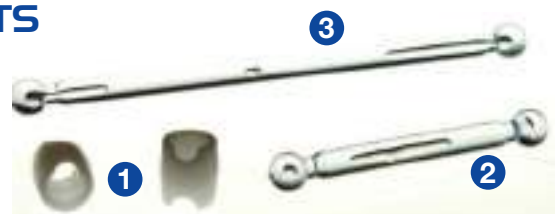

## SMALL SPRING CLAMP

With ball end.



#28422

## SUCTION CUP BASE

With ball end on stick.  
50mm dia.



#28411

## LARGE GRIPPER

Spring-loaded gripper with  
ball end holds up to 6mm  
thick material.



#28439

## CARDHOLDERS

With ball end.



#28437 27mm long  
#28438 50mm long

## SMALL MAGNET W/SIGNHOLDER

Assembled set consisting  
of 27mm cardholder with  
16mm dia. magnet.



#28460

## ANGLED MENU HOLDER

Clear base 60 x 38mm.



#505

## VERTICAL MENU HOLDER

Clear base – 50 x 45mm.

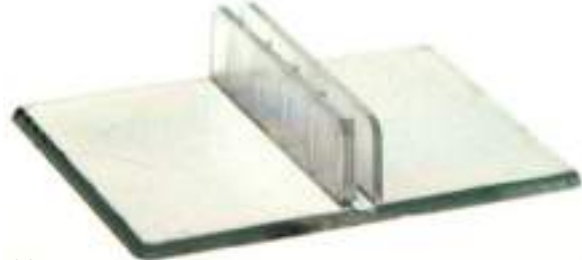

#506

# G

## TICKET FRAMES

<b>PLASTIC TICKET FRAMES</b> . . . . .	<b>70</b>
<b>PLASTIC TICKET FRAME HOOKS</b> . . . . .	<b>71</b>
<b>TICKET FRAME STANDS</b> . . . . .	<b>74</b>
<b>GALLOWS STAND</b> . . . . .	<b>76</b>
<b>WOODEN FRAMES</b> . . . . .	<b>77</b>
<b>“KLICK” FRAMES &amp; FITTINGS</b> . . . . .	<b>78</b>
<b>PRICING INSERT FRAMES</b> . . . . .	<b>83</b>
<b>CHALKBOARD INSERTS</b> . . . . .	<b>84</b>
<b>CHROME FRAME &amp; ACRYLIC TICKET HOLDERS</b> . . . . .	<b>85</b>

- The range of plastic ticket frames & accessories stocked by DISPLAY COMPONENTS provides a virtually endless array of solutions to point-of-sale advertising.
- Frames & accessories are manufactured in Europe from high-grade, unbreakable plastic materials.
- Frames stocked in sizes from A7 to A3 with sizes up to A1 available on special order.



## PLASTIC FRAMES

With ticket entry on short side.



- #11600 A6
- #11500 A5
- #11400 A4
- #11300 A3

Available in Clear(CL), Black(BL), Red(RD) & White(WH). Other colours and sizes available subject to minimum order quantities.

## PVC POSTER PROTECTOR

Non-reflective, Thin PVC sandwich allows for cheaper paper stock to be used while still looking great.

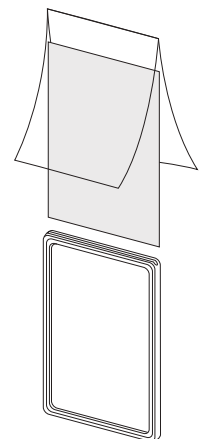

- #29260 A6 (0.2mm thickness)
- #29250 A5 (0.2mm thickness)
- #29240 A4 (0.2mm thickness)
- #29230 A3 (0.3mm thickness)
- #29220 A2 (0.3mm thickness)
- #29210 A1 (0.4mm thickness)

## U-FRAME

For ticket sizes A5 Landscape or A4 Portrait.



- #11407 Available in Red only.

## FRAME WITH CROSSBAR

Allows for A5 Landscape header panel with A4 Portrait under.



- #11445 Available in Red only.



## 90 DEGREE SUSPENSION RING

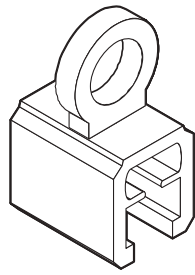

#21300 Clear plastic

## HANGING HOOK

Side-mounted clips for wire – allows for using top entry posters.



#21431 Pair of clips – Clear plastic

## PARALLEL SUSPENSION RING

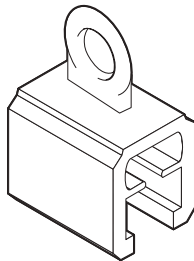

#21310 Clear plastic

## SWIVEL HANGING HOOK

Side-mounted for top entry posters.

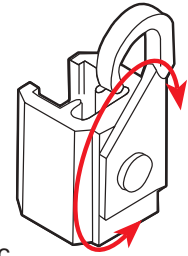

#21330 Pair of clips – Clear plastic

## SIDE-MOUNT SUSPENSION RING

Allows for use with top-loading frames.

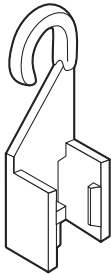

#21361 Clear plastic

## TUBE CLIP

Suspend frames from round rails with max. dia. 22mm.

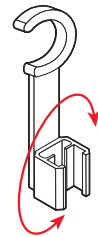

#21610 Pair of clips – Clear plastic

## SWIVEL SUSPENSION RING

Ring rotates to suspend frames in any direction.

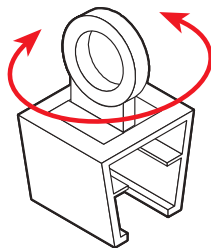

#21315 Clear plastic

## FRAME CONNECTOR

Connects 2 frames together.

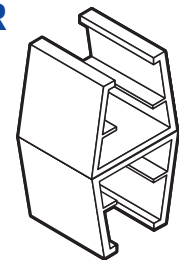

#21000 Clear plastic

## SUSPENSION HOOK

With hook on top to suspend frame. Side-mounted.

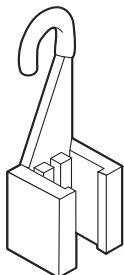

#21370 Clear plastic

## SWIVEL CONNECTOR

Rotating clip for connecting 2 frames at various angles.



#21010

## HANGING HOOK

To attach frames to wire baskets, etc.. with max. 10mm dia. wire.

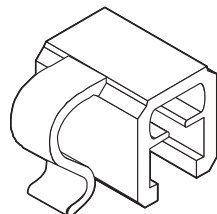

#21400 Clear plastic

## FRAME CONNECTOR

Side-mounted clip, joins frames with top poster insert.

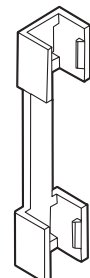

#21020 Clear plastic

## MAGNETIC SWIVEL FASTENER

With 1 magnet, clip rotates 360 deg.

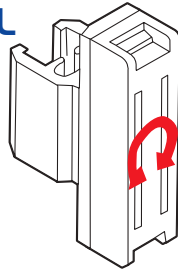

#21220 Clear

## VERTICAL BASE SUPPORT

Supports frames in upright position.

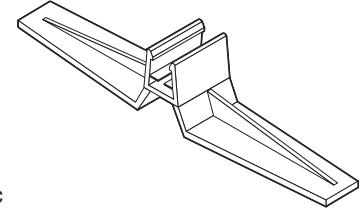

#21750 Clear plastic

## MAGNETIC FASTENER

With 1 magnet, fixed clip – 90 degrees.

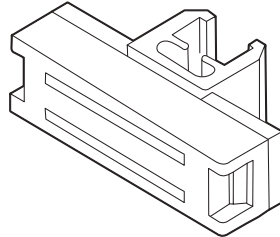

#21260 Clear plastic

## ANGLED BASE SUPPORT

Support frames at 15 degree angle.

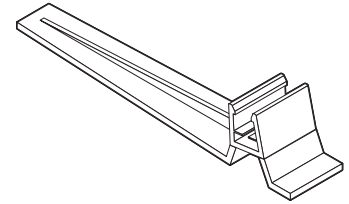

#21760 Clear plastic

## MAGNETIC FASTENER

For parallel fixing of frames to wall.



#21219 Clear plastic

## SHELF HOLDER

For shelf with drilled hole. Fitting has M8 internal thread.

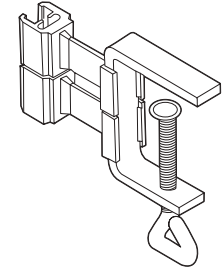

#21110 White

## SQUARE MAGNETIC FASTENER

With 2 magnets for parallel fixing of frame to wall

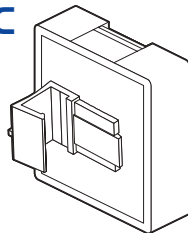

#21230 White base with clear plastic clip.

## WALL FASTENER

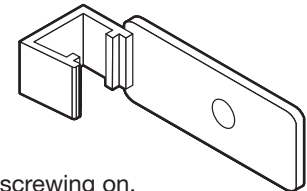

#21130 with hole for screwing on.  
#21131 with adhesive tape

## SQUARE MAGNETIC FASTENER

With 2 magnets for 90 degree fixing of frame to wall.

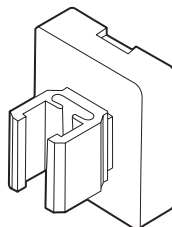

#21250 White base with clear plastic clip

## VERTICAL SWIVEL CLIP

#21120 with hole for screwing on.  
#21125 with adhesive tape.

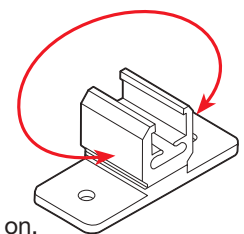

## SQUARE MAGNETIC FASTENER

With 2 magnets and swivel fixing clip.



#20377 White base with clear plastic clip.

## BOX CLAMP

To attach frames to cardboard boxes, cane baskets up to 20mm thickness.

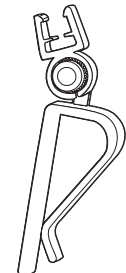

#21715 Clear plastic

## BOX CLAMP

To attach frames to boxes, fruit baskets, crates, etc... up to 22mm thickness. Set consists of clamp with hinged post and 'T' piece. Standard colour – Black. Order frame separately.

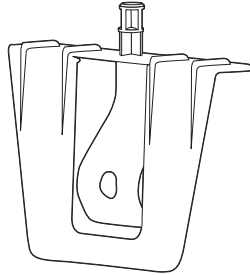

#35550



## T - PIECE

For connecting frames to stems.

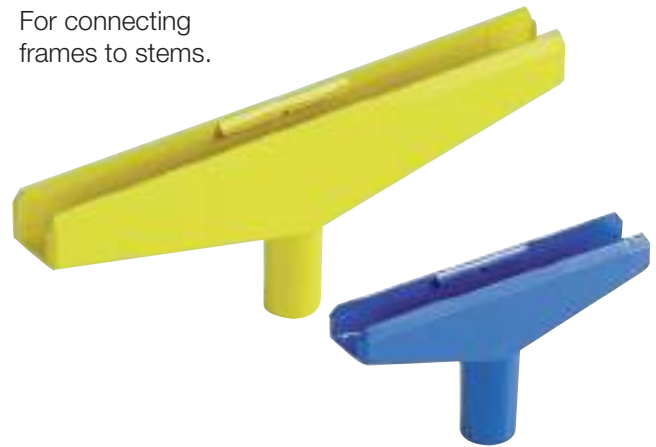

#20010 60mm – use for A5 & A6 frames.

#20011 – 90mm – use for A4 & A3 frames.

Available in Red(RD), Black(BL), White(WH) or Clear(CL).

## ALL-ROUNDER CLAMP

Revolving clamp with 155mm rod for a range of materials from 8 – 34mm thickness. Clamp has rubber inlay to prevent scratching. Order 'T' piece and frame separately. Standard colour – White.



#20560



## SQUARE HANGER

Connects frames at 90 degree angle, with hole for hanging.

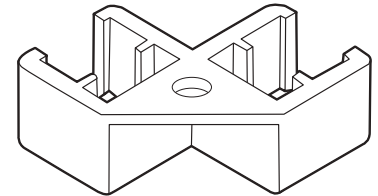

#21040 Clear plastic

## TRIANGULAR HANGER

Connects frames at 60 degree angle, with hole for hanging.

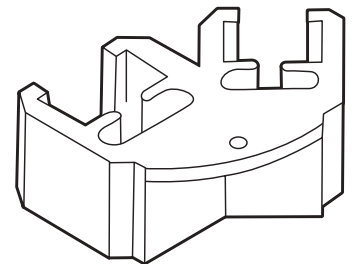

#22040 Clear plastic

## UNIVERSAL CLAMP

Very strong clamp for attaching to round or oval tubing up to 25mm diameter. Clear polycarbonate clamp with rubber inlay to prevent scratching. Order frame and 'T' piece separately.



#20570

## SPRING CLAMP

Vertically spring-loaded grey plastic retainers attach to wire grids & baskets, shopping trolleys and more.

Aluminium stem adjusts in height from 250-500mm. Includes 'T' piece - order frame separately.



#35435

Available in Red (RD) or Black (BL).

## OFFSET PLASTIC BASE

Designed to be free-standing or to slide under cartons. Use with 12mm dia. stems. Size – 250 x 90mm.



**#20390**  
Available in Red(RD), Black(BL), White(WH) or Clear(CL).

## OFFSET METAL BASE

Heavier weight base provides greater stability. Use with 12mm dia. stems. Size – 185 x 160mm.



**#20320**  
Available in Black(BL), Grey(GY)

## ROUND PLASTIC BASE

For use with 12mm dia. stems. Size – 160mm dia



**#20340**  
Available in Red(RD), Black(BL), White(WH) or Clear(CL).

## MAGNETIC BASE

White plastic base with either 2 or 4 magnets for use with 12mm dia. stems. Size – 100 x 40mm.

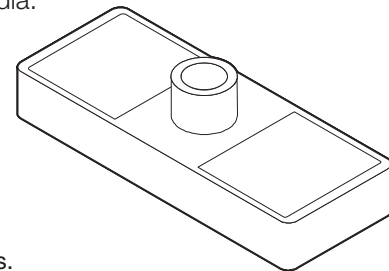

**#20370** 2 magnets.  
**#20372** 4 magnets.

## ROUND STEEL BASE

Heavy flat 5mm thick steel plate in White powdercoat finish. (Other colours available to special order).



**#20330** 160mm dia. – Weight – 0.6kg.  
**#20331** 255mm dia. – Weight – 2.0kg.  
**#20334** 345mm dia. – Weight – 3.8kg.



**#20200**  
STEM HOLDER (for use with 160mm dia. base only)

## ROUND MAGNETIC BASE

50mm dia. chrome base with magnetic force up to 18kgs. Includes tube holder to take 12mm dia. stems.



**#20375**

## CHROME STEMS

Fixed length chrome stems 12mm dia. with reduced top to fit T-piece.



- #20116 160mm
- #20131 310mm
- #20141 410mm

## ADJUSTABLE CHROME STEM

Adjustable length chrome stem, outer tube – 12mm dia., inner tube – 10mm dia. to fit T-piece.



- #20143 200 – 360mm
- #20144 320 – 620mm
- #20145 450 – 900mm
- #20146 600 – 1200mm

## ADJUSTABLE PLASTIC TUBE

Made from Black fibre reinforced plastic. Adjusts in height from 320 – 620mm. Outer tube – 12mm dia., inner tube – 10mm dia. To suit T-piece. Use with #20320 offset metal base.



#20162

## CLEAR PLASTIC STEMS

For use with 12mm dia. stems. Size – 160mm dia



- #20172 50mm
- #20173 75mm
- #20174 150mm

## TALL ADJUSTABLE STEMS

Adjustable height chrome tube with bolt on top to mount T-piece. Includes bottom connector for mounting to round steel bases (AP20331 & AP20334). Extends from 1000 – 1700mm.



#20176



## TALL ADJUSTABLE STEM

Adjustable height aluminium tube with bolt on top to mount T-piece or other fittings. Includes bottom connector for mounting to round steel bases (AP20331 & AP20334). Extends from 1300 – 2500mm.



#15376

Available in Black(BL), Grey(GY)



## GALLOWS STAND

Offset metal base with 600mm fixed tube with 1 or 2 gallows @ 310mm long each side (Order frame & hanging clips separately)



- #38731 Single-sided gallows
- #38631 Double-sided gallows

## GALLOWS STAND

Round steel base 160mm dia. With adjustable height chrome tube 600 – 1200mm with lever clamp. Available with 1 or 2 gallows @ 400mm long each side (Order frame & hanging clips separately)



- #38772 Single-sided gallows
- #38672 Double-sided gallows

## GALLOWS STAND

Round steel base 255mm dia. With aluminium tube 1600mm high. Available with 1 or 2 gallows @ 400mm long each side (Order frame & hanging clips separately)



- #38410 Single-sided gallows
- #38420 Double-sided gallows

## GALLOWS STAND

Round steel base 255mm dia. With adjustable height chrome tube 1000 – 1900mm. Available with 1 or 2 gallows @ 400mm long each side (Order frame & hanging clips separately)



- #38411 Single-sided gallows
- #38421 Double-sided gallows

## WOODLINE

Our range of WOODLINE timber frames and accessories provide real possibilities for creating that extra ambience that will distinguish you from the opposition.

- Manufactured from natural Beech timber with a clear lacquer for the genuine look.
- Compatible with a range of standard accessories that provide numerous display possibilities.
- Use with Chalk board inserts (see p.84 ) or clear plastic sleeves (see p.70)



## SHOWCARD FRAME

Available plain or with an M10 thread on the bottom for attaching directly to threaded stems. (Frame opening always on short side)



	Plain	With M10 thread
A5	#15350	#15351
A4	#15340	#15341
A3	#15330	#15331
A2	#15320	#13321
A1	#15310	

## WOODEN BASE

160mm dia. Beech wooden base with stepped pattern.



#20191

## ALUMINIUM THREADED STEM

Black finish, 16mm dia. - 320mm long. Use with frames with thread.



#15714

## WOODEN BASE LEGS (PAIR)

For holding frames upright. Includes screws for fixing.



#25882 Small  
#25880 Large

## WALL FASTENER

For direct wall fixing. Clear plastic.



#25180

## SWIVEL TUBE CLIP

To suspend frames from 20mm dia. horizontal rails. Clear plastic.

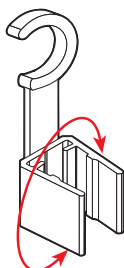

#25521

## SHOWCARD STAND

255mm dia. Black metal base with adjustable aluminium tube 1000 – 1900mm high with T-piece to suit timber frame. (Timber frame included).



#33384 A4  
#33383 A3

## KLICK "Shelf Barkers"

The KLICK range of "Shelf Barkers" are made from premium unbreakable plastic material and have an integral, moulded, dovetail retainer on the back, into which the amazing range of accessories will attach with a distinct "Klick". Frames stocked in RED – other colours available to special order, including "Chrome" finish.



## PLASTIC FRAMES

Choose from moulded plastic frames in choice of standard colors, or an exclusive range of injection-moulded, crystal-clear, frameless holders where your message is completely enclosed, without any distracting lines or colours.

### 1 Coloured frames



- 1 #13080 A8
- #13070 A7
- #13060 A6
- #13004 148 x 70mm
- #13003 210 x 59mm
- #13002 210 x 74mm
- #13001 210 x 99mm



### 2 Frameless, crystal-clear

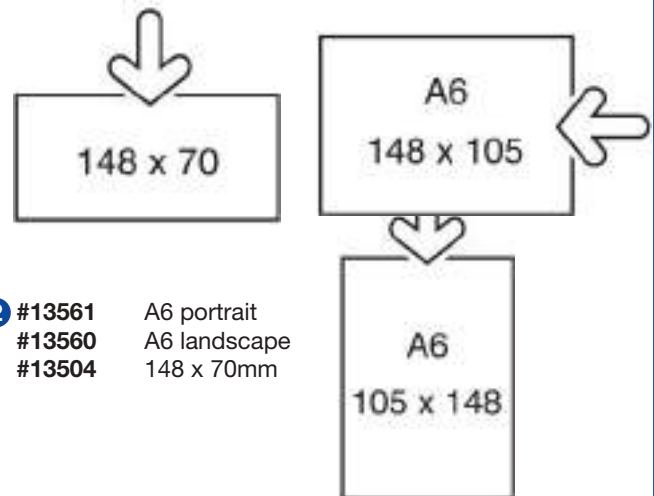

- 2 #13561 A6 portrait
- #13560 A6 landscape
- #13504 148 x 70mm

## SUPPORT CLIP

Frame support to free-stand frames.  
Colour – clear.

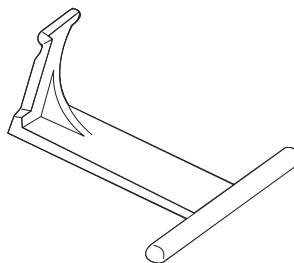

#23750

## HOOK CLIP

For wire baskets, containers, etc... Max. wire diameter – 10mm. Colour - white

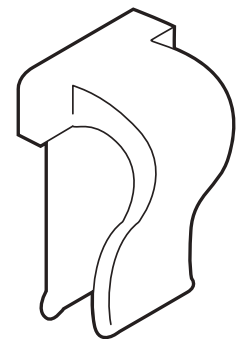

#23300

## VERTICAL GLASS CLIP

Fits panels up to 8mm thickness. Colour – white

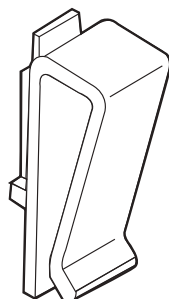

#23320

## VERTICAL METAL CLIP

Fits metal shelving with upright front edge. Colour – white

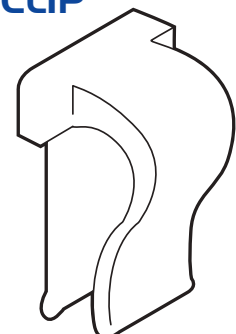

#23330



**"KLICK" ACCESSORIES**

**HOOK CLIP**

For wire baskets, small diameter tubes & rods up to 20mm. Colour – white.

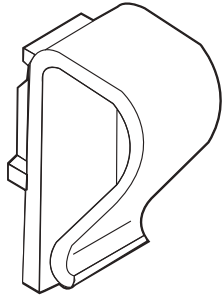

#23310

**COIL SPRING CLIP – STANDARD**

For tables, shelves with front lip up to 60mm deep. Colour – white.

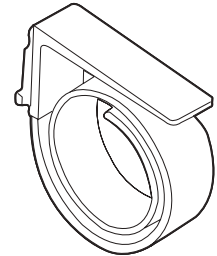

#23100

**CARDBOARD CLAMP**

Attaches to cardboard cartons, etc... up to 10mm in thickness. Colour – clear.

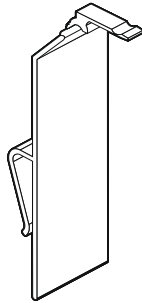

#23710

**METAL SHELF CLIP**

Attaches to Euro style metal shelving with front lip. Colour – white.

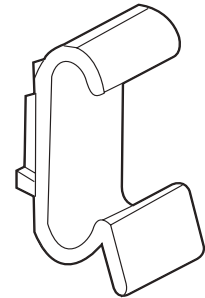

#23610

**CARDBOARD CLAMP**

Attaches to trays, containers, baskets, etc.. up to 20mm thick. Colour – clear.



#23715

**METAL SHELF CLIP**

Attaches to Euro style metal shelving with front lip. Longer arm – made of flexible plastic. Colour – white.

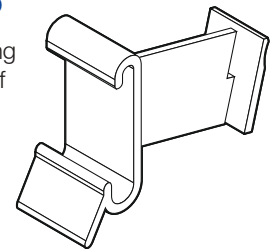

#23600

**SHELF FASTENER**

For shelves or boards up to 10m thickness. Colour – white.

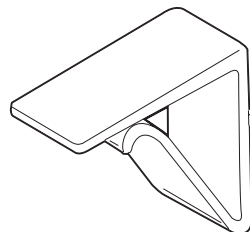

#23160

**DATA STRIP CLIP**

Attaches to the front of plastic data strip.

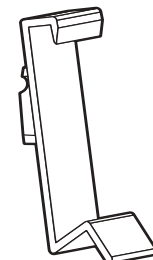

#23661

**SLATWALL CLIP**

Colour – white.

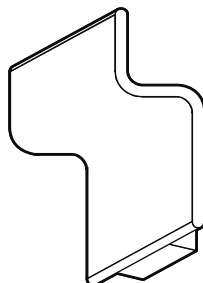

#23780

**TICKET RAIL CLIP**

Designed to attach inside 40mm ticket channel. Colour – white.

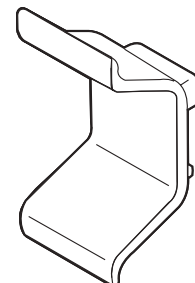

#23560

**VERTICAL MAGNET**

Colour – clear.

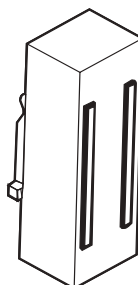

#23220

**SUCTION CUP**

Colour – clear.

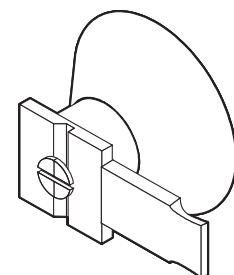

#23700

# "KLICK" ACCESSORIES

## HORIZONTAL MAGNET

Colour – clear.

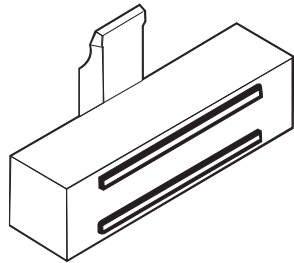

#23225

## SWIVEL PIN CLIP

Adjustable angle clip with pin for attaching to product, eg. wool. Colour – white.

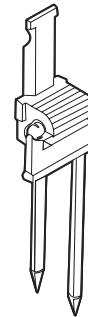

#23830

## TUBE CLIP

Fits round tube 23 – 28mm dia  
Colour – white.

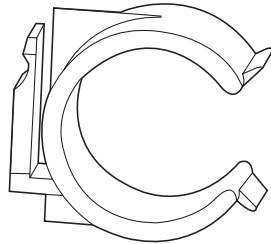

#23500

## STICK PIN

Stainless steel pin for attaching to food.



#23820

## OVAL TUBE CLIP

Fits oval tube 30 x 15mm.  
Colour – white.

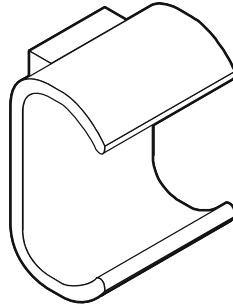

#23510

## TUBE ADAPTOR

Connects to 10mm dia. tubular chrome stems. Colour – white.

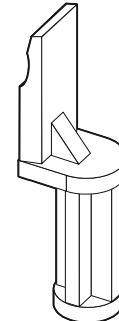

#23810

## SQUARE TUBE CLIP

Colour – white. Fits square tube  
20 x 20mm. Colour – clear.

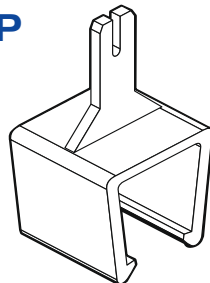

#23460

## STRAIGHT CONNECTOR

To connect several frames  
together. Colour – clear.

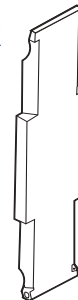

#23010

## SCREW-ON WALL FASTENER

For fixing flat against wall.  
Colour – clear.

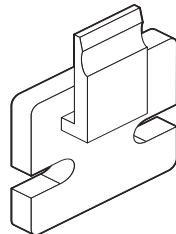

#23130

## ADHESIVE WALL FASTENER

With double-sided tape.  
Colour – clear.

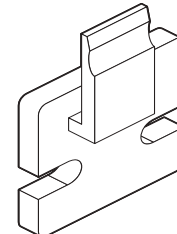

#23131

## HINGED ADAPTOR

With double-sided tape. Colour – clear.

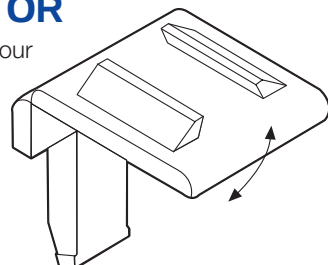

#23140

## ADHESIVE PLATE

With double-sided adhesive for  
use with combination of other  
clips. Colour – white.

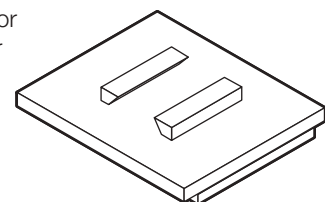

#23150

# "KLICK" ACCESSORIES

## CONNECTOR

For connecting Universal & Tray Clips onto KLICK frames at varying angles. Colour – clear.

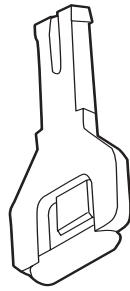

#23940

## RODS

For connecting KLICK frames onto Base, Universal or Tray Clips. Colour – clear.

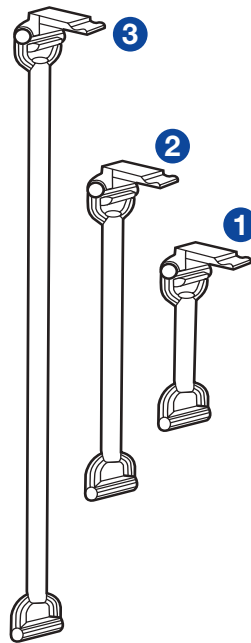

- ① #23905 50mm long
- ② #23910 100mm long
- ③ #23920 200mm long

## PLASTIC BASE

Clear plastic base to take the various length rods below. Allows for various angles.

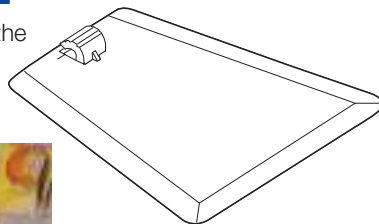

#23900

## SWIVEL HINGE

Use with combination of other clips to fix frames at an inclined angle. Colour – clear.

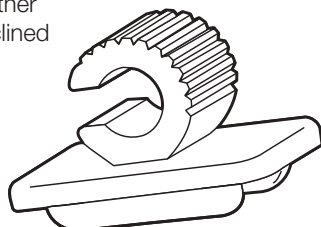

#23815

## LARGE SWIVEL CLAMP

Very powerful clamp to attach KLICK frames to crates, cane baskets up to 30mm in thickness. Includes KLICK adaptor with rotary ball joint. Colour – Black.



#17070

## ICE STICK

Use in for attaching KLICK frames in fish counters. Length – 150mm, breakable down to 110mm. Colour – clear.

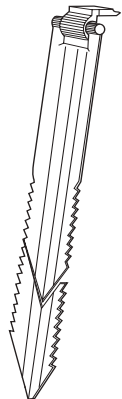

AP23065

## UNIVERSAL CLIP

For use with rods or connector. Colour – clear.

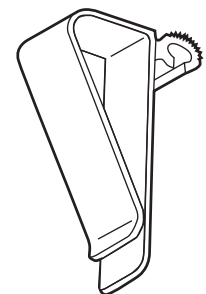

#23960

## TRAY CLIP

For use with rods or connector. Colour – clear.

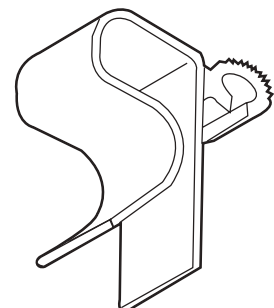

#23950

# "KLICK" ACCESSORIES

## MAGNETIC SHOPPER-STOPPER

With square magnet and swivel arm. Due to gravity, the frame will always rest at 90° to shelf.



- #33956 A6 Landscape
- #33966 A6 Portrait
- #33913 A5 Portrait
- #33914 A5 Landscape
- Red frame with white arm

## MAGNETIC BANNER HANGER

Magnetic base 60 x 35mm with hinged fitting with aluminium tube. Includes 2 x clear tube hooks.



- #26670 250mm long tube
- #26671 400mm long tube

## PEGBOARD SHOPPER-STOPPER

Attaches to Euro-style metal peg panel. Includes 320mm chrome stem and elastic frame clips that will allow standard frames to swing back to the starting position. Order frame separately.



#21725

## BANNER HANGER

Zinc finish metal bar 10mm dia. That attached to 50mm centre slotted systems. Adjustable in length from 400 - 750mm. Includes 2 x grey plastic tube hooks.



#26680

## CURVED BANNER HANGER

Magnetic base 60 x 35mm with 250mm long bent aluminium tube on hinge fitting. Includes 2 x clear tube hooks.



#26672

## SPRING CLAMP W/SWIVEL ADAPTOR

Set consists of large spring clamp in clear plastic with swivel fitting with adaptor to suit the range of KLICK frames.



#23815



## BASIC PRICE FRAME – 110 x 85mm

Available in standard frame colours.



#13191

Plain white PVC insert (for wording)

#24140 104 x 40mm

Clear PVC cover sheet

AP24145 104 x 40mm

## FOLDED NUMBER STRIPS

Available in standard frame colours.



#24105 2 small + 4 large digits

#24105A 6 large digits

## BASIC PRICE FRAME – 155 x 110mm

Available in standard frame colours.

#13192

Plain white PVC insert (for wording)

#24127 148 x 57mm

Clear PVC cover sheet

#24128 148 x 57mm

## FOLDED NUMBER STRIPS

Available in standard frame colours.

#24126 2 small + 3 large digits

#24126A 6 large digits

## FRAME WITH PRICE DISPLAY

Showcard frame in A3 or A4 size with 5 spiral-bound numbers each, printed black on white with small & large numbers. Includes plain white PVC insert. Available in Red only.



- #14140 A4 frame size (A5 landscape plain insert)
- #14130 A3 frame size (A4 landscape plain insert)

## CHALK BOARD INSERT

Polystyrene sheet coated on both sides with black slate. With rounded edges to fit frames.



- #29680 A8 74 x 53mm
- #29670 A7 105 x 74mm
- #29660 A6 148 x 105mm
- #29691 148 x 70mm
- #29683 210 x 59mm
- #29684 210 x 74mm
- #29688 210 x 99mm
- #29650 A5 210 x 148mm
- #29640 A4 297 x 210mm
- #29630 A3 420 x 297mm
- #29620 A2 594 x 420mm
- #29610 A1 840 x 594mm

## PRICE CASSETTE W/CLEAR COVER

Consists of coloured plastic price cassette with rear KLIICK adaptors, Moulded clear covers clip on to provide complete protection for the numbers and message.



- #13249 Includes 6-digit number strips (3 big, 2 small + unit information).



- #13230 For fruit & vegetables. Includes 7-digit number strips, printed green on white. Overall size – 160 x 90mm.

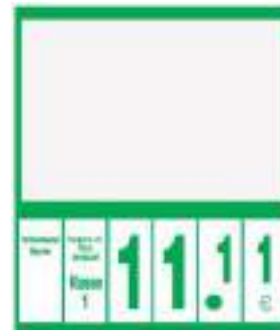

- #13251 Large frame for fruit & vegetables. Includes 6-digit number strips, printed green on white. Overall size – 221 x 264mm.

## CHALK BOARD MARKER

Water-soluble white marker.



- #24281 5mm tip
- #24280 15mm tip

## CHROME FRAME SIGNHOLDER

Deluxe mitred corner frames with fitting to suit threaded stems.

- #545 A4 Portrait
- #546 A4 Landscape
- #547 A5 Portrait
- #549 A3 Landscape



## ACRYLIC FRAME SIGNHOLDER

On chrome channel with fitting to suit threaded stem.

- #518 A5 Portrait
- #518L A5 Landscape
- #519 A4 Portrait
- #519L A4 Landscape



## THREADED STEMS

Threaded both ends.

- #520 75mm (L)
- #521 150mm (L)
- #523 230mm (L)
- #524 300mm (L)
- #486 Adjustable height 300 - 500mm



## CHROME BASE

For threaded stems - 125mm dia.

#485



## MAGNETIC BASES

For threaded stems - 125mm dia.

### **Straight**

- #525 75mm (L)
- #525A 150mm (L)

### **Corner**

Magnetic - for mounting onto rack and metal tubing.

#526



## MAGNETIC CORNER CLAMP

Magnetic Corner Clamp with threaded fitting.

#0526

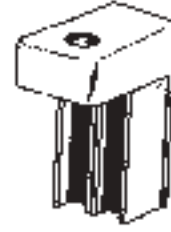

## UNIVERSAL CLAMP

With threaded fitting. Clamps on to 25mm square, 38 x 12 rectangular or up to 32mm dia. round tube.

#0524



## SPRING CLAMP

With threaded fitting. Clamps onto 12mm thick material.

#0863



## SWEDGE CUPS

Fits into 16mm dia hole - to suit swedged square stem.

#0571 Chrome finish die cast  
#0572 Clear polycarbonate



## SWEDGE STEM

To suit swedges cup fitting - other end threaded to suit signholder.

#0573 75mm  
#0574 150mm



## CHROME CHANNEL

With threaded fitting.

#0519COMP 300mm

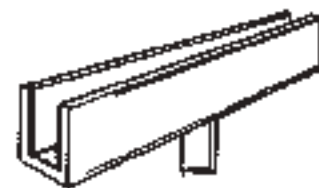



# H

## METAL TUBING CONNECTORS

<b>SYSTEM OVERVIEW</b> .....	<b>88</b>
<b>'PRIMO' SQUARE TUBE</b> .....	<b>90</b>
<b>'JOKER' CLEAR FITTINGS</b> .....	<b>94</b>
<b>'JOKER' METAL TUBE FITTINGS</b> .....	<b>95</b>
<b>'JOKER' TUBE BENDS</b> .....	<b>97</b>
<b>'JOKER' PANEL CONNECTORS</b> .....	<b>98</b>
<b>'JOKER' SHELF SUPPORTS</b> .....	<b>99</b>
<b>'UNO' METAL TUBE FITTINGS</b> .....	<b>100</b>
<b>'TRITIX' SPACE FRAME SYSTEM</b> .....	<b>102</b>
<b>'TRITIX' 3-TUBE TRIANGLE FRAMES</b> .....	<b>104</b>
<b>'TRITIX' 4-TUBE SQUARE FRAMES</b> .....	<b>107</b>
<b>'TRITIX' SHELF BRACKETS</b> .....	<b>109</b>

## PRIMO (Square Tube)

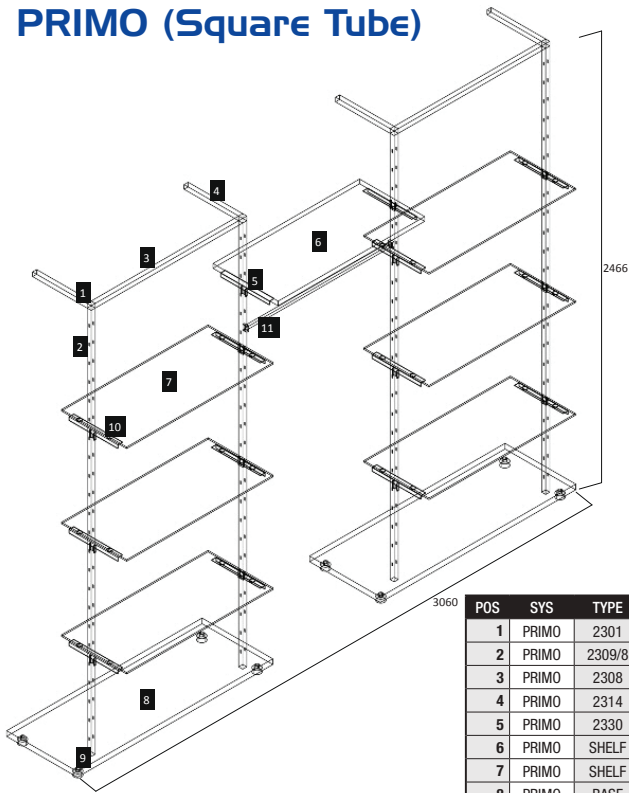

POS	SYS	TYPE	A (mm)	B (mm)	C (mm)	PCS
1	PRIMO	2301	25	25		4
2	PRIMO	2309/8	25	25	2375	4
3	PRIMO	2308	905			2
4	PRIMO	2314	25	25	335	2
5	PRIMO	2330	300			7
6	PRIMO	SHELF	900	400	25	1
7	PRIMO	SHELF	900	400	8	6
8	PRIMO	BASE	1200	430	30	2
9	PRIMO	FEET	M110	Ø50		8
10	PRIMO	2532	Ø23			24
11	PRIMO	2323/3	875			1

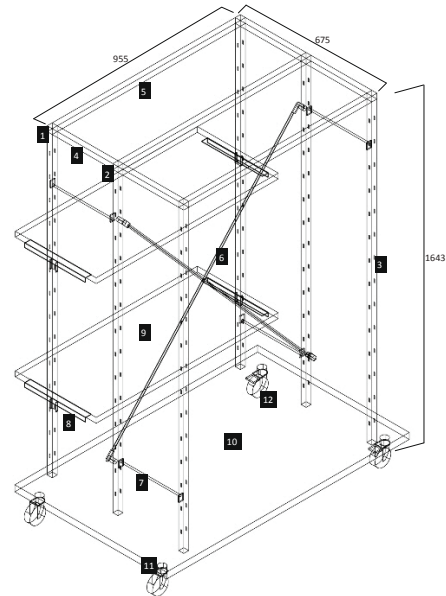

POS	SYS	TYPE	A (mm)	B (mm)	C (mm)	PCS
1	PRIMO	2301	25	25		4
2	PRIMO	2302	25	25		2
3	PRIMO	2309/5	25	25	1475	6
4	PRIMO	2308	25	25	300	4
5	PRIMO	2308	25	25	905	3
6	PRIMO		1402	Ø10		2
7	PRIMO		300	Ø10		4
8	PRIMO	2330	300			2
9	PRIMO	SHELF	900	400	25	2
10	PRIMO	BASE	1200	750	30	1
11	PRIMO	2345	M10	15	Ø80	2
12	PRIMO	2346	M10	15	Ø80	2

## JOKER/UNO (Round Tube)

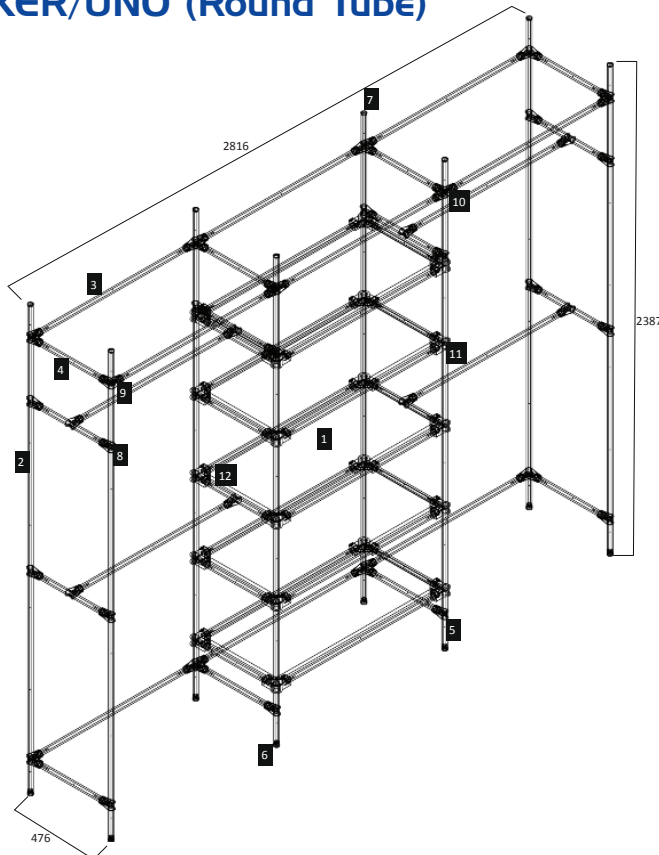

POS	SYS	TYPE	A (mm)	B (mm)	C (mm)	PCS
1	FLY	SHELF	900	400	18	5
2	JOKER	846/8	2375	Ø25		8
3	JOKER	846/8	853	Ø25		23
4	JOKER	846/8	553	Ø25		24
5	JOKER	2212	Ø25	M10		8
6	JOKER	2214	Ø35	M10		8
7	JOKER	2208	Ø25			8
8	UNO	2401	Ø25			24
9	UNO	2404	Ø25			6
10	UNO	2407	Ø25			6
11	UNO	2404	Ø25			20
12	UNO	2425	34	100.4		20

## TRITIX (Ladder Tubes)

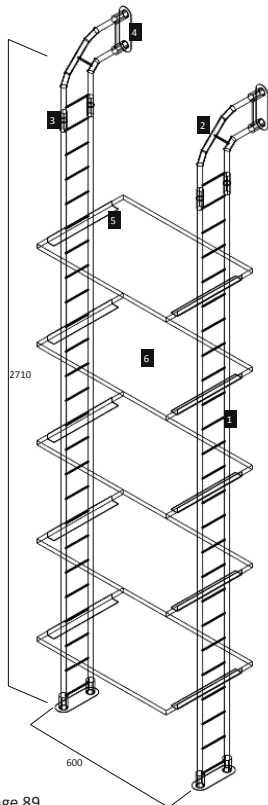

POS	SYS	TYPE	A (mm)	B (mm)	C (mm)	PCS
1	TRITIX	2501/80	1088	100		2
2	TRITIX	2504	300	300		4
3	TRITIX	2259	Ø25			8
4	TRITIX	2514	50			4
5	TRITIX	2519	915			1
6	TRITIX	2522	300			3
7	TRITIX	SHELF	900	400	18	3

Page 89

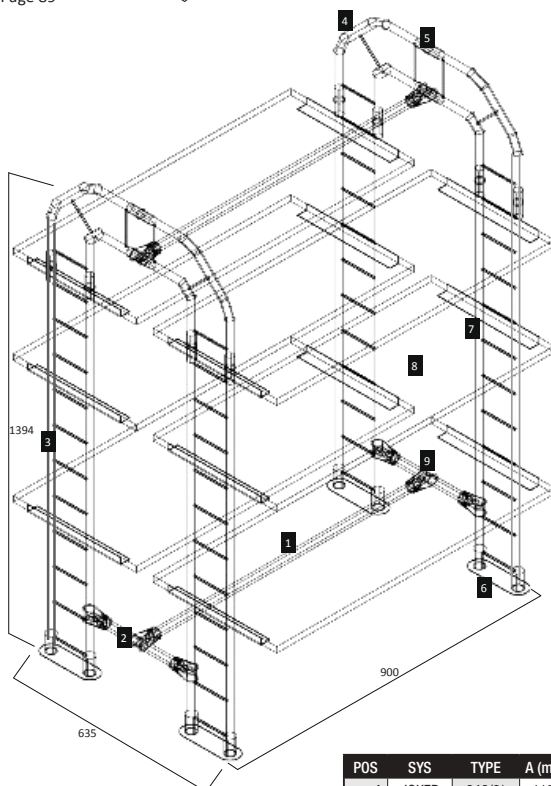

POS	SYS	TYPE	A (mm)	B (mm)	C (mm)	PCS
1	JOKER	846/8*	1153	Ø25		2
2	JOKER	846/8*	354	Ø25		2
3	TRITIX	2501/80	1088	100		4
4	TRITIX	2504	300	300		4
5	TRITIX	2559	Ø25			12
6	TRITIX	2514	50			4
7	TRITIX	2522	300			6
8	TRITIX	SHELF	900	400	18	6
9	UNO	2401	Ø25			8

\* cut to length

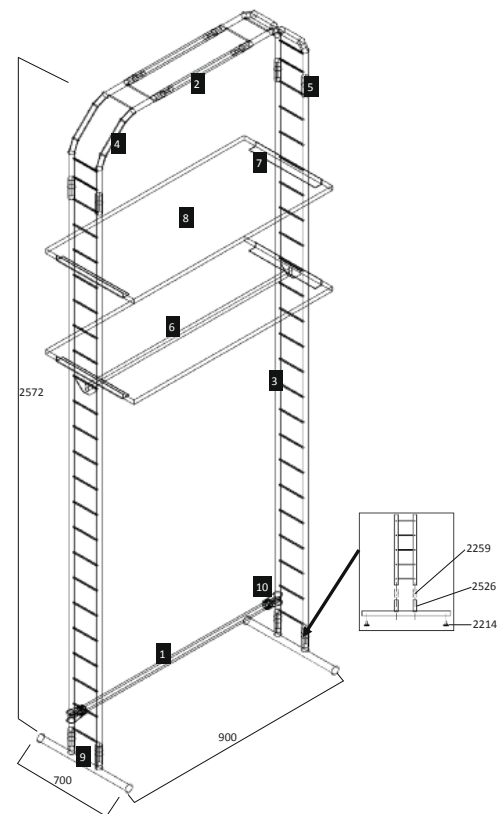

POS	SYS	TYPE	A (mm)	B (mm)	C (mm)	PCS
1	JOKER	846/8*	1153	Ø25		2
2	JOKER	846/8*	354	Ø25		2
3	TRITIX	2501/240	2388	100		2
4	TRITIX	2504	300	300		2
5	TRITIX	2259	Ø25			12
6	TRITIX	2519	915			1
7	TRITIX	2522	300			2
8	TRITIX	SHELF	600	400		2
9	TRITIX	2527	700	100		2
10	UNO	2401	Ø25			4

\* cut to length

The 'PRIMO' system allows endless design possibilities with 25mm square tube by providing a secure 'friction-fit' connection in a range of configurations.

A large range of standard accessories are available for a multitude of functional and decorative applications, including panel mounting, shelving or mobile stands.

Corners are tapped in place with a rubber mallet. Standard finishes are Bright Chrome(C) or Brushed Chrome(SC).



## 3-WAY CORNER



#2301C Chrome finish  
#2301SC Satin Chrome

## 4-WAY CORNER



#2302C Chrome finish  
#2302SC Satin Chrome

## 5-WAY CORNER



#2303C Chrome finish  
#2303SC Satin Chrome

## 2-WAY CORNER



#2305C Chrome finish  
#2305SC Satin Chrome

## 3-WAY 'T' JOINT



#2306C Chrome finish  
#2306SC Satin Chrome

## 4-WAY CROSS JOINT



#2307C Chrome finish  
#2307SC Satin Chrome

## SQUARE TUBE

25mm square x 1.2mm wall thickness.  
Length – 3000mm



#2308C Chrome finish  
#2308SC Satin Chrome

## ECONOMY SQUARE TUBE

Chrome finish only.



#5050/6 1830mm  
#5050/8 2440mm

## SQUARE TUBE SLOTTED 2 SIDES

For attaching various brackets.  
Chrome finish only.



#2309/5C 1475mm  
#2309/8C 2375mm

## SQUARE TUBE SLOTTED 4 SIDES

For attaching various brackets.  
Chrome finish only.



#2310C 2375mm

## WALL SPACERS (PAIR)

With sleeve for wall attachment.  
Has holes for shelf bracket pins.  
Chrome finish only.



#2314C 335mm

## SHELF PINS (SET OF 4)

Fit onto wall spacers at top of upright tube.



#2315C 110mm high

## FIXING PLATE - 'L' SHAPE

With adjustable foot.  
Screws onto bottom frame. Chrome finish.



#2316C 90 x 90mm x 80mm high.

## FIXING PLATE - 'T' SHAPE

With adjustable foot.  
Chrome finish.



#2317 155 x 90mm x 80mm high.

## FIXING PLATE - CROSS SHAPE

With adjustable foot.  
Screws onto bottom frame. Chrome finish.



#2318C 155 X 155mm x 80mm high.

## FIXING PLATE - 'L' SHAPE (for castors)

Screws onto bottom frame.  
Chrome finish.



#2319 90 x 90mm high.

## FIXING PLATE - 'U' SHAPE (for castors)

Screws onto bottom frame.  
Chrome finish.



#2320C 155 x 155mm high.

## CASTORS

80mm dia.  
With M10  
thread.



#2345 Plain  
#2346 With brake

## HANGING BAR

Hooks between slotted uprights.  
Chrome finish.



2323/2 600mm  
2323/3 900mm

## DOUBLE-SIDED FACEOUT

For central hanging bar.  
Chrome finish.



#2325 250mm either side.

## CENTRAL HANGING BAR

For mounting onto 4 slotted  
uprights. Chrome finish.



#2326/3 900mm long x 330mm wide.

## CENTRAL HANGING BAR

For mounting onto 4 slotted  
uprights. Chrome finish.



#2327/3 900mm long x 430mm wide.

## CENTRAL HANGING BAR

For mounting onto  
4 slotted uprights.  
Chrome finish.



#2328/3 900mm long x 650mm wide.

## SHELF BRACKETS (PAIR)

For mounting onto  
slotted uprights.  
Chrome finish



#2329/13 330mm  
#2329/17 430mm  
#2329/26 650mm

## CENTRAL SHELF BRACKETS (PAIR)

For mounting  
onto slotted  
uprights.  
Chrome  
finish..



#2330 300mm

## CENTRAL SHELF BRACKETS (PAIR)

Allows for simple  
removal of shelf.  
Chrome finish.



#2364 180mm.

## SHELF SUPPORTS (SET OF 4)

Allows for simple removal of shelf.



#2363

## FIXING PLATE - 'L' SHAPE

Screws onto top of frame for additional support.  
Chrome finish.



#2355 90 x 90mm

## FIXING PLATE - 'T' SHAPE

Screws onto top of frame for additional support.  
Chrome finish.



#2356 155 x 90mm

## FIXING PLATE - CROSS SHAPE

Screws onto top of frame for additional support. Chrome finish.



#2357 155 X 155mm

## FIXING FLANGE

For wall mounting - includes grub screw to fasten tube.



#2371C Chrome finish  
#2371SC Satin Chrome

## TUBE JOINER

With socket screw expander.



#2372 80mm long.

## PANEL SUPPORT

For 6mm thick panel.



#2373C Chrome finish  
#2373SC Satin Chrome

## SHELF SUPPORT

For shelf thickness up to 12mm.

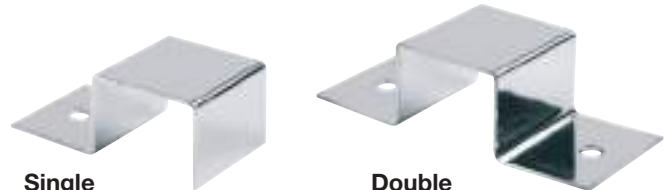

**Single**  
#2375C Chrome finish  
#2375SC Satin Chrome

**Double**  
#2376C Chrome finish  
#2376SC Satin Chrome

## PANEL HOOK



#2377C Chrome finish  
#2377SC Satin Chrome

## DOUBLE HOOK



#2378C Chrome finish  
#2378SC Satin Chrome

# 'JOKER' CLEAR FITTINGS

## JOKER' CLEAR FITTINGS

JOKER clear fittings are injection moulded from clear polycarbonate to provide some interesting display configurations using 25.4mm dia. chrome tube or clear acrylic tubing.

Fittings simply tighten onto the tubing with an allen key.



## SIX-WAY CONNECTOR



#1474

## THREE-WAY CONNECTOR



#1470

## SHELF SUPPORT

Special design feature allows for side-by-side placement on continuous shelving run.



#1475

## FOUR-WAY CONER CONNECTOR



#1471

## PANEL CLAMP



#1476 - For 5mm thickness panel.  
#1477 - For 10mm thickness panel.  
#1478 - For 20mm thickness panel.

## FOUR-WAY STRAIGHT CONNECTOR



#1472

## FLANGE



#7549

## FIVE-WAY CONNECTOR



#1473

## TUBING



Chrome  
#846/2 - 700mm (L)  
#846/5 - 1525mm (L)  
#846/6 - 1830mm (L)  
#846/8 - 2440mm (L)  
Clear Acrylic 3mm thickness  
#7515 - 1830mm (L)



# 'JOKER' TUBING SYSTEMS

## JOKER' TUBING SYSTEMS

'JOKER' is the collective name for this amazing system of components for connecting 25mm dia. tubing and fittings in ways that have never before been possible.

Seriously, you can now construct a whole range of framing structures with combinations of shelving and panel infills in a variety of materials.

Ideal for both permanent and temporary exhibits by simply cutting tubing to length and joining connectors.



## CHROME TUBING

25mm dia. chrome tubing.



- #846/2 - 700mm (L)
- #846/5 - 1600mm (L)
- #846/6 - 1830mm (L)
- #846/8 - 2440mm (L)

## TUBE END CAP

Chrome plated plastic end cap.



Rounded  
#2241



Spherical  
#2213



Flat  
#2208

## THREADED END CAP & LEVELLER



#2212



#2214

## CUTTING TOOL

Wheel cutter.



#2205

## WALL FLANGE

With tightening grub screw.



#2215

## SPECIAL ALLEN KEY



#2210

## EXPANDING SOCKET

For joining 2 x tubes into continuous length.



#2259

# 'JOKER' TUBING SYSTEMS

## ORTHOGONAL JOINTS

For connecting 3 continuous tubes at right angles.

#2201R  
R/H Joint.



#2201L  
L/H Joint.



## PARALLEL JOINTS - DOUBLE TUBE

#2207



#2202



## CROSS JOINTS

For connecting 2 continuous tubes at right angles

#2231R R/H Joint.



#2231L L/H Joint.



## PARALLEL JOINTS - TRIPLE TUBE

#2230 Triple.



## SLIDING 'T' JOINT

#2209



## ROTATING JOINTS

#2256 Double.



## END JOINT

For 'T' connection. With slots for panels.

#2203



#2257 Triple.



# 'JOKER' TUBE BENDS

**CURVED TUBE 90°**



#2221 - 370mm x 370mm

**ANGLE BENT  
TUBE 135°**



#2270 - 200mm x 200mm

**CURVED TUBE 180°**



#2222  
540mm (W) x 370mm (L)  
#2223  
940mm (W) x 370mm (L)

**2-BEND  
TUBE 90°**



#2271 - 300mm x 300mm

**BENT TUBE 90°**



#2226  
200mm x 200mm

**3-BEND  
TUBE 180°**



#2272 - 540mm x 300mm  
#2273 - 940mm x 300mm

**'U' BENT TUBE**



#2224 - 540mm x 300mm  
#2225 - 940mm x 300mm

**4-BEND  
TUBE 180°**



#2274 - 540mm x 300mm  
#2275 - 940mm x 300mm

**PROJECTING 'U' BENDS**



#2227  
540mm (L) x 300mm (W) x 200mm (H)  
#2228  
940mm (L) x 300mm (W) x 200mm (H)

**INCLINED ANGLE  
TUBE 180°**



#2276 - 540mm x 370mm

# 'JOKER' PANEL CONNECTOR

## SINGLE PANEL CONNECTOR



#2249

## PANEL SUPPORT



#2236  
Chrome-plated steel.

#2236A  
Clear plastic.

## DOUBLE PANEL CONNECTOR



#2255

## PANEL SUPPORT

Screws onto thicker panels.



#2238  
Chrome-plated steel.

#2238A  
Clear plastic.

## HINGED DOUBLE PANEL CONNECTOR



#2278

## GLASS SHELF SUPPORT



#2240  
Clear plastic.

## PANEL SUPPORT



#2233  
Chrome-plated steel.

## SHELF SUPPORT



#2232  
Chrome-plated steel.

# 'JOKER' SHELF SUPPORTS

## SHELF SUPPORT



#2250 - 300mm

## FRONTAL SHELF SUPPORT

60° downslope.



#2262  
250mm

## ANGLE SHELF SUPPORT - LH



#2251L - 300mm

## CLAMP-ON SHELF SUPPORT

Single.



#2263  
300mm

## ANGLE SHELF SUPPORT - RH



#2251R - 300mm

## CLAMP-ON SHELF SUPPORT

Double support for 2 shelves on common upright.



#2264  
300mm

## FRONTAL SHELF SUPPORT

Horizontal.



#2260 - 325mm

## SHELF CLAMP SINGLE

Clamps onto any thickness shelf.



#2280

## FRONTAL SHELF SUPPORT

30° downslope.



#2261 - 250mm

## SHELF CLAMP DOUBLE

Clamps onto any thickness shelf.



#2281

## 3-WAY 'T' CLAMP



#2401C

## 4-WAY CROSS CLAMP



#2403C

## 4-WAY CORNER CLAMP



#2404C

## 5-WAY 'T' CLAMP



#2407C

## 4-WAY HINGED CORNER CLAMP



#2415C

## PARALLEL DOUBLE CLAMP



#2402C

## PARALLEL TRIPLE CLAMP



#2405C

## SCREW COVER CAP

Chrome cover cap for the socket screws.



#2418C

## PARALLEL CLAMP

For various thickness panels, glass, etc...  
Purchase the appropriate thickness panel sleeve separately.



#2416C

## PANEL SLEEVE



#2417/6 to suit panel thickness 6mm  
#2417/12 to suit panel thickness 12mm  
#2417/20 to suit panel thickness 20mm

**HEAVY DUTY 3-WAY  
'T' CLAMP**



#2426C

**HEAVY DUTY 5-WAY 'T' CLAMP**

#2428C

**HEAVY DUTY  
4-WAY HINGED  
CORNER**



#2427C

**HEAVY DUTY 6-WAY  
CROSS CLAMP**



#2429C

**SHELF SUPPORT**

For round tubing.



#2425C

**'PRIMO' SINGLE  
SHELF SUPPORT**



#2430C  
#2430SC

**'PRIMO' DOUBLE  
SHELF SUPPORT**



#2431C  
#2431SC

**SUCTION CUP**

For glass shelves.



#2532

- A complete system of interchangeable components to enable you to create amazing display situations.
- Provides an overhead frame structure to delineate an area and can be used as a functional system for shelving, etc...
- Based on 25mm diameter steel tube in 2 (Simple), 3 (Tri-) or 4(Quad-) tube columns.
- The components are available in Bright Chrome finished steel tubing. Special colours and alternative finishes are available on request.



## SIMPLE COLUMN

Double tube uprights with cross bars at 100mm centres. Chrome finish.

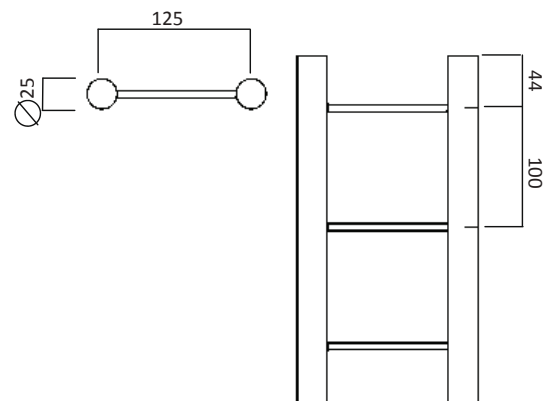

### Overall length

#2501/50C	788mm
#2501/80C	1088mm
#2501/110C	2188mm
#2501/240C	2388mm
#2501/300C	2988mm

## SIMPLE VERTICAL BEND



#2504C Overall dimension – 300 x 300mm

## SIMPLE HORIZONTAL BEND



#2505C Overall dimension – 300 x 300mm



## SIMPLE DECORATIVE ENTRANCE GABLE



**#2509C**  
Overall dimension  
910mm wide x 265mm high.

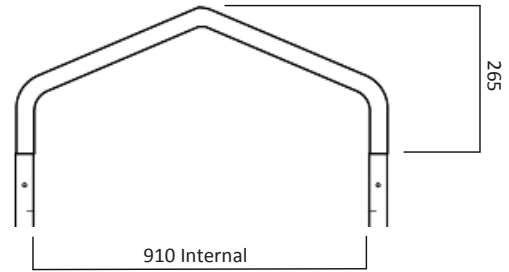

## SIMPLE VERTICAL CORNER - MITRED



**#2547C** Overall dimension – 300 x 300mm

## SIMPLE HORIZONTAL CORNER - MITRED



**#2548C** Overall dimension – 300 x 300mm

## SIMPLE WALL/ FLOOR PLATE

With tightening screws.



**#2514C**

## SIMPLE BASE SUPPORT



**#2526C** Overall length – 400mm  
**#2527C** 700mm

## SIMPLE COLUMN BASE

380 mm diameter steel base including fixings for column. Standard finish – Powdercoat 'Hammered Black'



**#2531**

## TUBING SPIGGOT

Socket screw tightening for joining of round tubes. Required for all connectors/bases to columns. Chrome finish.



**#2259**

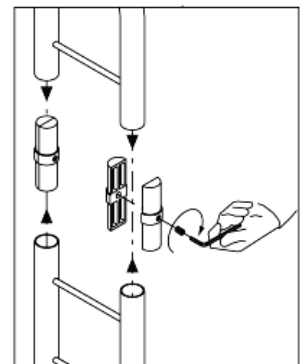

## TRI - COLUMN

Triple tube uprights with cross bars at 100mm centres. Chrome finish.

	Overall length
#2502/50C	788mm
#2502/80C	1088mm
#2502/110C	2188mm
#2502/240C	2388mm
#2502/300C	2988mm

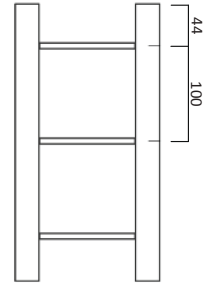
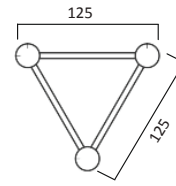

## TRI - 90 DEGREE BEND

With slanted end.



#2506C  
Overall dimension  
300 x 300mm

## TRI - 90 DEGREE BEND

With straight external end.



#2507C  
Overall dimension  
300 x 300mm.

## TRI - 90 DEGREE BEND

With inner tube.



#2543C  
Overall size  
300 x 300mm.

## TRI - DECORATIVE ENTRANCE GABLE

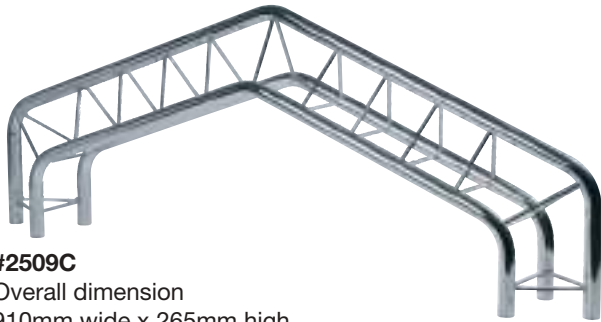

**#2509C**  
Overall dimension  
910mm wide x 265mm high.

## TRI - CROSS CONNECTOR



**#2544C**  
Overall size  
300 x 300mm.

## TRI - 'T' CONNECTOR

With straight external end.



**#2545C**  
Overall size  
300 x 225mm.

## TRI - 90 DEGREE BEND - MITRED



**#2449C**  
Overall size  
300 x 300mm.

## TRI - 120 DEGREE BEND

With external tube.

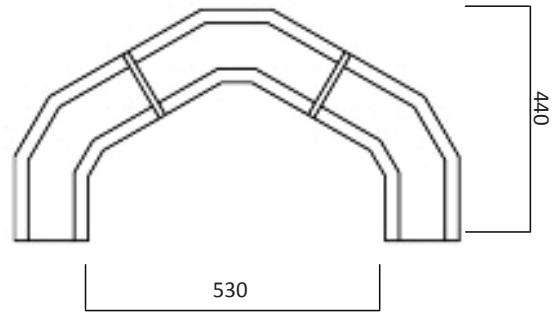

#2551C

Overall size  
340 x 270mm.

## TRI - COLUMN BASE

380 mm diameter steel base including fixings for column. Standard finish – Powdercoat 'Hammered Black'



#2532

## TRI - PYRAMID COLUMN TOP

Chrome finish.

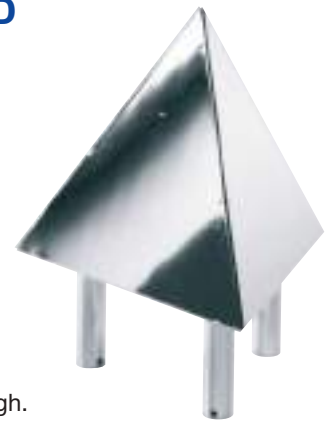

#2546C

Overall size  
200mm wide x 190mm high.

## TRI - WALL/ FLOOR PLATE

With tightening screws.



#2516C

## SOCKET SCREW SPIGGOT

For 'Cubic' joint (below). Expands to fit tubing.



#2512

## 'CUBIC' JOINT

Used as a junction for either 'Simple', 'Tri' or 'Quad' columns. Purchase the required amount of spigots (above). Chrome finish.



#2511C

Overall size  
165mm cube

## 'QUAD' COLUMN

4 x tube uprights with cross bars at 100mm centres. Chrome finish.

	Overall length
#2503/50C	788mm
#2503/80C	1088mm
#2503/110C	2188mm
#2503/240C	2388mm
#2503/300C	2988mm

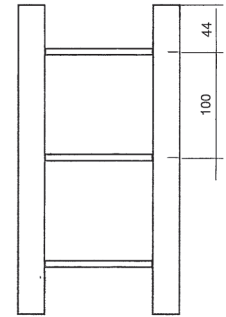
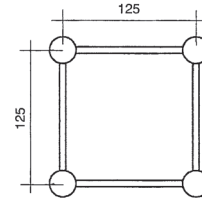

## QUAD - 90 DEGREE BEND



#2508C  
Overall dimension  
300 x 300mm.

## QUAD - 90 DEGREE BEND - MITRED



#2550C  
Overall dimension  
300 x 300mm

## QUAD - 120 DEGREE BEND



#2552C  
Overall dimension  
335 x 280mm

## QUAD CROSS CONNECTOR



#2553C

Overall size  
300 x 300mm

## QUAD 'T' CONNECTOR



#2554C

Overall size  
300 x 225mm

## QUAD COLUMN BASE

380mm diameter steel base, including fixings for column. Powdercoat finish – 'Hammered Black'.



#2533

## QUAD WALL/ FLOOR PLATE

With tightening screws.  
Chrome finish.



#2517C

## STRAIGHT SHELF BRACKETS (PAIR)

Centred hooks. Chrome finish.



#2522C Length – 300mm

## STRAIGHT SHELF BRACKETS (PAIR)

Off-centred hooks. Chrome finish.



#2523C Length – 300mm

## SLOPING SHELF BRACKETS (PAIR)

Centred hooks. Chrome finish.



#2555C Length – 300mm

## SLOPING SHELF BRACKETS (PAIR)

Off-centred hooks. Chrome finish.



#2556C Length – 300mm

## HANGRAIL

2 x hook-on brackets with oval tube. Chrome finish.



#2519C Overall length – 915mm

## WALL BRACKET

Use where additional support for the structure is required.



#2518C Length – 235mm (may be trimmed to suit)

ITEM#	P#	ITEM#	P#	ITEM#	P#	ITEM#	P#	ITEM#	P#	ITEM#	P#
0231	17	0564	13	1471	94	1733	60	1840	36	2228	97
0243	15	0571	86	1472	94	1735	60	1840	42	2230	96
0246	16	0572	86	1473	94	1736	59	1841	40	2231L	96
0247	15	0573	86	1474	94	1738	61	1842	40	2231R	96
0370	11	0574	86	1475	94	1739	62	1843	40	2232	98
0371	11	0575	13	1476	94	1740	62	1844	40	2233	98
0400	53	0576	13	1477	94	1741	62	1846	40	2236	98
0401	53	0577	13	1478	94	1742	62	1847	40	2236A	98
0402	53	0600	7	1484	24	1744	62	1848	40	2238	98
0403	53	0601	7	1485	24	1750	56	1849	40	2238A	98
0404	53	0603	7	1494	24	1751	56	1850	44	2240	98
0405	53	0604	7	1495	24	1752	61	1851	44	2241	95
0411	53	0605	7	1501	46	1753	56	1852	44	2249	98
0412	53	0630	14	1502	46	1759	58	1853	44	2250	99
0413	53	631	14	1503	46	1759	59	1854	44	2251L	99
0414	53	0631A	14	1504	46	1767	56	1855	44	2251R	99
0415	53	0635	14	1505	46	1768	56	1856	41	2255	98
443/2H	53	0636	14	1506	46	1770/12	56	1857	44	2256	96
443/DST	53	0637	14	1507	46	1770/18	56	1858	41	2257	96
443/PL	53	0660	5	1508	47	1770/24	56	1859	41	2259	95
0444/2H	53	0661	5	1508A	47	1770/30	56	1860	44	2259	103
0444/DST	53	0662	5	1509	47	1770/36	56	1861	41	2260	99
0444/PL	53	0663	5	1510	47	1770/4	56	1861	44	2261	99
0445/2H	53	0667P	5	1511	47	1770/6	56	1862	44	2262	99
0445/DST	53	0667S	5	1512	46	1771	57	1865	44	2263	99
0445/PL	53	0668P	5	1513	47	1772	57	1870	44	2264	99
0446/2H	53	0668S	5	1514	48	1773	57	1871	44	2270	97
0446/DST	53	0670	12	1514A	48	1774	57	1873	44	2271	97
0446/PL	53	0671	12	1515	48	1774A	57	1876	44	2272	97
0447/2H	53	0672	12	1516	48	1774HD	57	1877	44	2273	97
0447/DST	53	0673	12	1517	48	1776/3	58	1881L	39	2274	97
0447/PL	53	0674	12	1518	46	1776/4	58	1881P	39	2275	97
0448/PL	53	0675	12	1520	49	1776/8	58	1882L	39	2276	97
0479	65	0676	12	1521	49	1777	58	1882P	39	2278	98
0485	85	0677	12	1522	49	1778	58	1883P	39	2280	99
0486	85	0678	12	1523	49	1778	59	1885L	39	2281	99
0487	65	0695	6	1524	49	1779	59	1885P	39	2301C	80
0489	65	0696	6	1527	46	1780/10	58	1886P	39	2301SC	90
0490	65	704/26	64	1528	50	1780/3	58	1890P	39	2302C	90
0491	65	705/26	64	1530	48	1780/4	58	1891L	39	2302SC	90
0492	65	0750	18	1531	48	1780/8	58	1891P	39	2303C	90
0496	65	0751	18	1533	49	1787/3	59	1892L	39	2303SC	90
0497	65	0752	18	1535	50	1787/4	59	1892P	39	2305C	90
498	65	0753	18	1537	50	1787/5M	59	1898	38	2305SC	90
505	68	0755	18	1540CL	52	1787/8	59	1899	38	2306C	80
0506	68	0756	18	1543	52	1789/3	59	1900	36	2306SC	90
0507/8	64	0757	18	1546	49	1789/4	59	1910	36	2307C	90
0507A	64	0758	18	1548/49	51	1789/8	59	1912	40	2307SC	90
0508	65	0758	18	1550L	51	1792/3	59	1913	40	2308C	90
0509	65	0770	18	1550P	51	1792/4	59	1917	40	2308SC	91
0510	65	0771	18	1551/56	51	1792/8	59	1919	40	2309/5C	91
0510A	65	0772	18	1552/56	51	1793	61	1923	40	2309/8C	91
0511	65	0773	18	1553/49	51	1794	62	1927	40	23100	91
0512	65	0775	18	1554L	51	1795	62	1929	40	2310C	79
0512A	65	0776	18	1554P	51	1797	62	1950	42	23130	91
0513	65	0777	18	1555B	51	1798	62	1951	42	23131	80
0514	65	0778	18	1570	52	1799	62	1955	43	23140	80
0518	85	0785	18	1574	52	1800	36	1961	42	2314C	80
0518L	85	0786	18	1575	52	1800L	36	1965	41	23150	91
0519	85	0787	18	1576	49	1801	37	1966	41	2315C	81
0519COMP	86	0788	18	1578	48	1802	37	1967	43	23160	91
0519L	85	0790	18	1583	52	1803	42	1968	43	2316C	79
0520	85	0791	18	1584	52	1803	44	1969	43	2316C	91
0521	85	0792	18	1588	49	1805	37	1970	43	2317	91
0523	85	0793	18	1589	49	1806	37	1971	43	2318C	91
0524	85	0820	14	1590	47	1807	42	1972	43	2320C	91
0524	86	0821	14	1591	47	1807	44	1973	9	2323/2	92
0525	85	0822	14	1593	52	1809	42	2064/49	51	2323/3	92
0525A	85	0823	14	1594	52	1809	44	2201L	96	2325	92
0526	85	0824	14	1595	48	1810	44	2201R	96	2326/3	92
0526	86	0825	14	1596	48	1811	38	2202	96	2327/3	92
0527/26	64	0826	14	1597	46	1812	38	2203	96	2328/3	92
0527/39	64	0826A	14	1599	47	1813	38	2205	95	2329/13	92
0528/26	64	0830	13	1654	54	1816	44	2207	96	2329/17	92
0528/39	64	0831	13	1655	54	1817	38	2208	95	2329/26	92
0528/52	64	0832	13	1656	54	1818	44	2209	96	2330	92
0545	85	0833	13	1657	54	1819	38	2210	95	2345	92
0546	85	0834	13	1658	54	1823	38	2212	95	2346	92
0547	85	0846/2	94	1659	54	1826	36	2213	95	2355	93
0549	85	0846/2	95	1689	61	1827	38	2214	95	2356	93
0550	13	0846/5	94	1705	63	1829	38	2215	95	2357	93
0551	13	0846/5	95	1730/A0	60	1831	41	2221	97	2363	93
0552	13	0846/6	94	1730/A1	60	1832	41	2222	97	2364	92
0553	13	0846/6	95	1730/A2	60	1833	41	2223	97	2371C	93
0560	13	0846/8	94	1730/A3	60	1835	40	2224	97	2371SC	93
0561	13	0846/8	95	1730/A4	60	1835	41	2225	97	2372	93
0562	13	0863	86	1731	62	1837	41	2226	97	2373C	93
0563	13	1470	94	1732	60	1839	41	2227	97	2373SC	93



ITEM#	P#	ITEM#	P#	ITEM#	P#	ITEM#	P#	ITEM#	P#	ITEM#	P#
2375C	93	7005	2	7151	9	7508	20	15351	77	23940	81
2375SC	93	7006	2	7152	9	7509	20	15714	77	23950	81
2376C	93	7007	2	7155	9	7510	20	17070	77	23960	81
2376SC	93	7010	2	7156	33	7515	20	20010	73	24105	83
2377C	93	7011/4	2	7157	33	7515	94	20011	73	24126A	83
2377SC	93	7011/6	3	7160	33	7516	20	20116	75	24127	83
2378C	93	7012	3	7161	9	7517	20	20131	75	24128	83
2378SC	93	7021	3	7162	9	7518	20	20141	75	24140	83
2401C	92	7022	4	7200	9	7519	20	20143	75	24145	83
2402C	100	7023	4	7201	7	7520	20	20144	75	24280	84
2403C	100	7024	4	7202	7	7521	20	20145	75	24281	84
2404C	100	7025	4	7203	7	7522	20	20146	75	25180	77
2405C	100	7026	4	7205	7	7525	20	20162	75	25521	77
2407C	100	7027	4	7206	7	7530	20	20172	75	25880	77
2415C	100	7028	4	7210	7	7535	20	20173	75	25882	77
2416C	100	7029	9	7215	7	7536	20	20174	75	26670	82
2417/12	100	7030	8	7216	28	7537	20	20176	75	26672	82
2417/20	100	7032	8	7220	28	7538	20	20191	77	26680	82
2417/6	100	7032	8	7221	28	7539	20	20200	74	28405	67
2418C	100	7033	9	7222	28	7540	20	20320	74	28406	67
2425C	100	7034	8	7225	28	7545	20	20320	75	28407	67
2426C	101	7040	8	7226	28	7546	20	20330	74	28408	67
2427C	101	7041	4	7230	28	7547	20	20331	74	28411	68
2428C	101	7042	4	7231	28	7549	20	20334	74	28415	67
2429C	101	7043	5	7241	28	7570	94	20370	74	28417	67
2430C	101	7044	5	7242	31	7571	21	20372	74	28420	67
2430SC	101	7045	8	7251-03	31	7572	21	20375	74	28422	68
2431C	101	7046	3	7251-04	27	7573	21	20377	72	28424	67
2431SC	101	7047	3	7251-05	27	7576	21	20390	74	28425	67
2449C	101	7048	5	7251-06	27	7580	21	20560	73	28425	67
2501/110C	105	7049	5	7251-07	27	7581	21	20570	73	28437	68
2501/240C	102	7051	5	7251-08	27	7590	21	21000	71	28438	68
2501/300C	102	7052	30	7251-10	27	7591	21	21010	71	28439	68
2501/50C	102	7053	30	7251-11	27	7601	21	21020	71	28460	68
2501/80C	102	7054	30	7251-12	27	7603	22	21040	73	29210	60
2502/110C	102	7055	30	7251-14	27	7604	22	21110	72	29210	70
2502/240C	104	7059	32	7251-16	27	7605	22	21120	72	29220	60
2502/300C	104	7060	30	7251-17	27	7606	22	21125	72	29220	70
2502/50C	104	7061	7	7251-19	27	7607	22	21130	72	29230	60
2502/80C	104	7062	7	7251-21	27	7610	22	21131	72	29230	70
2503/110C	104	7064	7	7251-22	27	7611	21	21219	72	29240	60
2503/240C	107	7065	32	7251-24	27	7615	21	21220	72	29240	70
2503/300C	107	7066	32	7251-25	27	7617	21	21230	72	29250	60
2503/50C	107	7067	32	7265	27	7620	21	21250	72	29250	70
2503/80C	107	7070	30	7268	26	7621	23	21260	72	29260	70
2504C	107	7071	29	7269	26	7622	23	21300	71	29301	54
2505C	102	7072	29	7271	26	7625	23	21310	71	29302	54
2506C	102	7073	29	7272	31	7801	23	21315	71	29303	54
2507C	104	7074	29	7275	31	7803	23	21330	71	29304	54
2508C	104	7075	32	7276	26	7805	23	21361	71	29610	84
2509C	107	7076	32	7325	26	7807	23	21370	71	29620	84
2509C	103	7077	32	7326	10	7810	23	21400	71	29630	84
2511C	105	7080	29	7327	10	7812	23	21431	71	29640	84
2512	106	7081	29	7328	10	7815	23	21610	71	29650	84
2514C	106	7083	29	7330	16	7817	23	21715	72	29660	84
2516C	103	7084	32	7331	16	8852	23	21725	82	29670	84
2517C	106	7085	29	7332	16	8852A	36,43	21750	72	29680	84
2518C	108	7086	32	7333	16	11300	36	21760	72	29683	84
2519C	109	7087	32	7334	16	11400	70	22040	81	29684	84
2522C	109	7088	32	7334	15	11407	70	23010	73	29688	84
2523C	109	7089	32	7335	16	11445	70	23065	90	29691	84
2526C	109	7094	32	7336	15	11500	70	23220	79	33383	77
2527C	103	7101	29	7338	15	11600	70	23225	80	33384	77
2532	103	7102	10	7339	17	13001	70	23300	78	33913	82
2532	101	7103	10	7340	17	13002	78	23310	79	33914	82
2533	106	7104	10	7350	17	13003	78	23320	78	33956	82
2543C	108	7105	10	7351	11	13004	78	23330	78	33966	82
2544C	104	7106	10	7352	11	13060	78	23460	80	35435	73
2545C	105	7107	10	7353	11	13070	78	23500	80	35550	73
2546C	105	7108	10	7354	11	13080	78	23510	80	38410	76
2547C	106	7109	10	7360	11	13191	78	23560	79	38411	76
2548C	103	7111	10	7361	11	13192	83	23600	79	38420	76
2550C	103	7113	10	7362	11	13230	83	23610	79	38421	76
2551C	107	7114	10	7363	11	13249	84	23661	79	38631	76
2552C	106	7116	10	7364	11	13251	84	23700	79	38672	76
2553C	107	7117	10	7415	11	13321	84	23710	79	38731	76
2554C	108	7118	10	7450	26	13504	77	23715	79	38772	76
2555C	108	7119	10	7451	31	13560	78	23750	78		
2556C	109	7130	10	7455	31	13561	78	23780	79		
4472	109	7131	6	7456	31	14130	78	23810	80		
5033	23	7133	6	7460	31	14140	84	23815	81		
5034	57	7134	6	7461	31	15310	84	23815	82		
5039	57	7135	6	7465	31	15320	77	23820	80		
5050/6	91	7136	6	7503	31	15330	77	23830	80		
5050/8	91	7137	10	7504	20	15331	77	23900	81		
7000	57	7138	10	7505	20	15340	77	23905	81		
7002	2	7139	10	7506	20	15341	77	23910	81		
7004	2	7150	10	7507	20	15350	77	23920	81		